

NOTES: UNLESS OTHERWISE SPECIFIED.

REVISIONS				
REV	DESCRIPTION	DATE	APP.	REV. BY
0	INITIAL RELEASE			--

PRELIMINARY PRINT

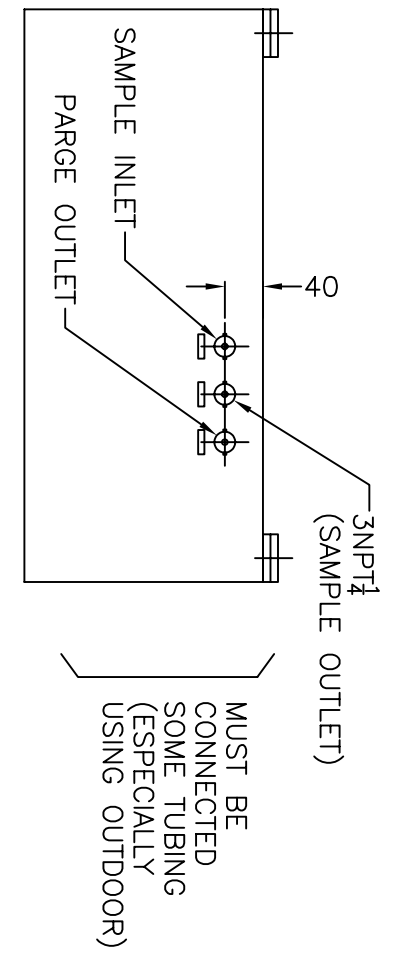
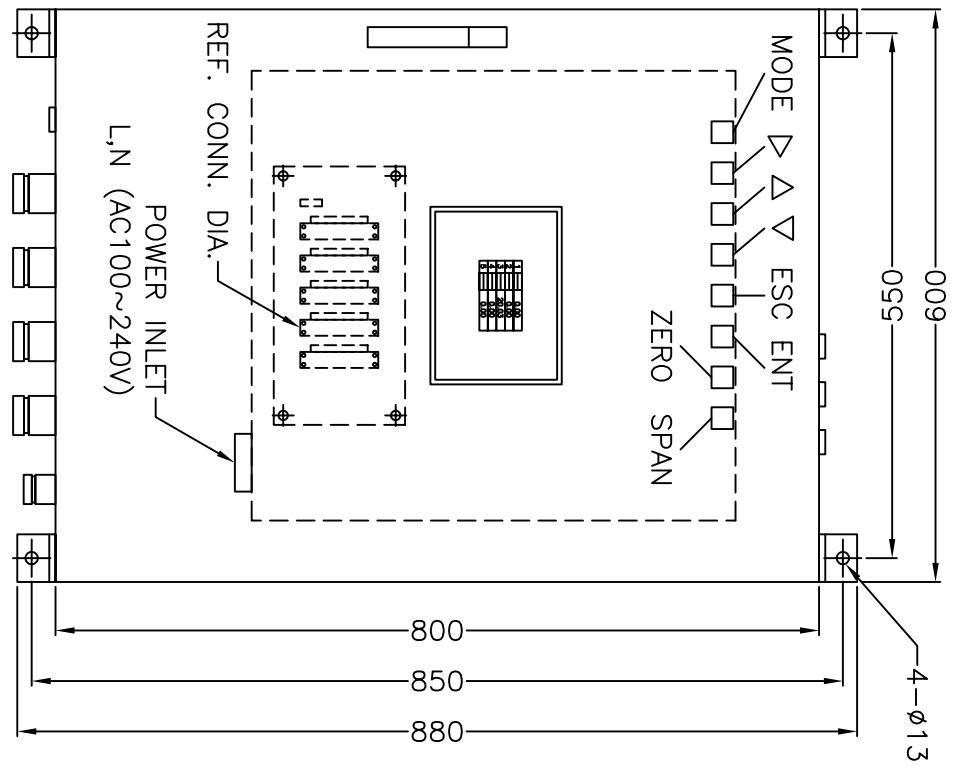
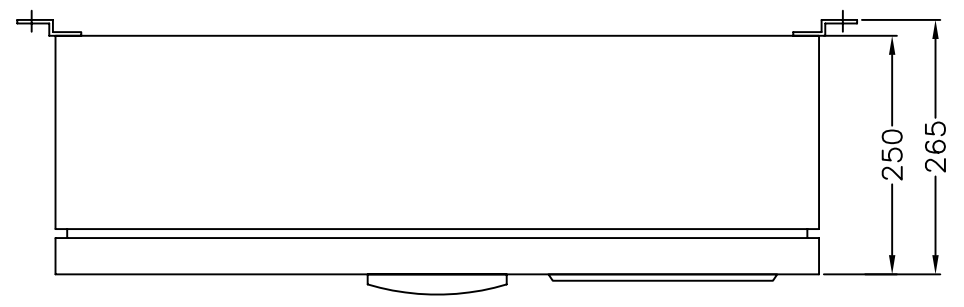
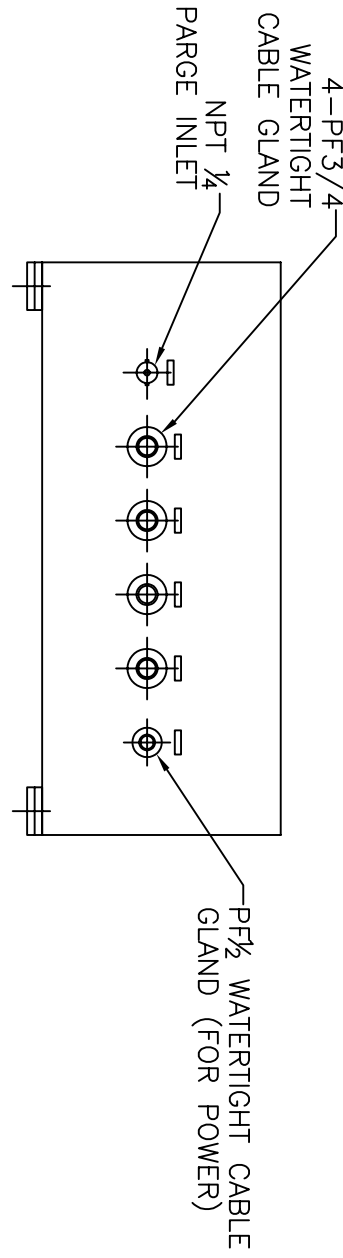

DO NOT SCALE DWG
 TOLERANCE UNLESS OTHERWISE SPECIFIED: ANGULAR ±1/2°
 LINEAR { .X = ±.1
 .XX = ±.02
 .XXX = ±.010

THIS DRAWING IS THE PROPERTY OF TELEDYNE INSTRUMENTS AND CONTAINS CONFIDENTIAL INFORMATION. IT IS NOT TO BE COPIED, REPRODUCED OR USED WITHOUT WRITTEN PERMISSION.

TELEDYNE INSTRUMENTS
Analytical Instruments
 A Teledyne Technologies Company
 City of Industry, California, 91748, USA

S/	SIGNATURES	DATE
N/	DRFT: K.MURALI	24/05/06
I/	CHK:	
P/	APPR:	
O/	ENGR:	
F/	C.O.: PROPOSAL	
REFERENCE	CAD I.D. BSK240506-2-0	

TITLE OUTLINE DIAGRAM OF INFRARED ANALYZER (WALL MOUNT TYPE) 7500/7600 SERIES	SCALE NONE
	SIM
	SHEET 1 OF 2
MATL. NONE	DWG NO. BSK-240506-2
	REV 0

NOTES: UNLESS OTHERWISE SPECIFIED.

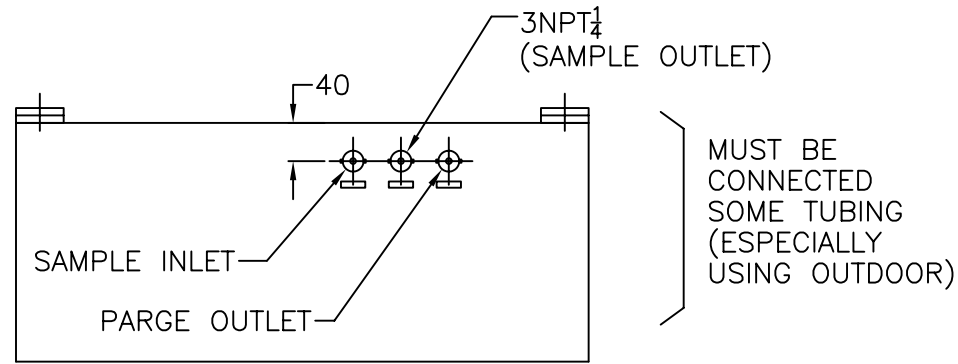

REVISIONS				
REV	DESCRIPTION	DATE	APP.	REV. BY
0	INITIAL RELEASE			--

PRELIMINARY PRINT

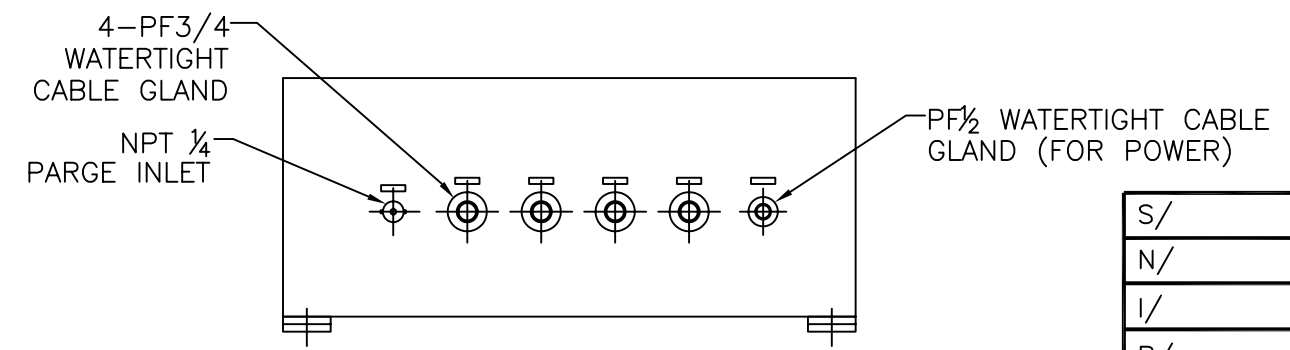
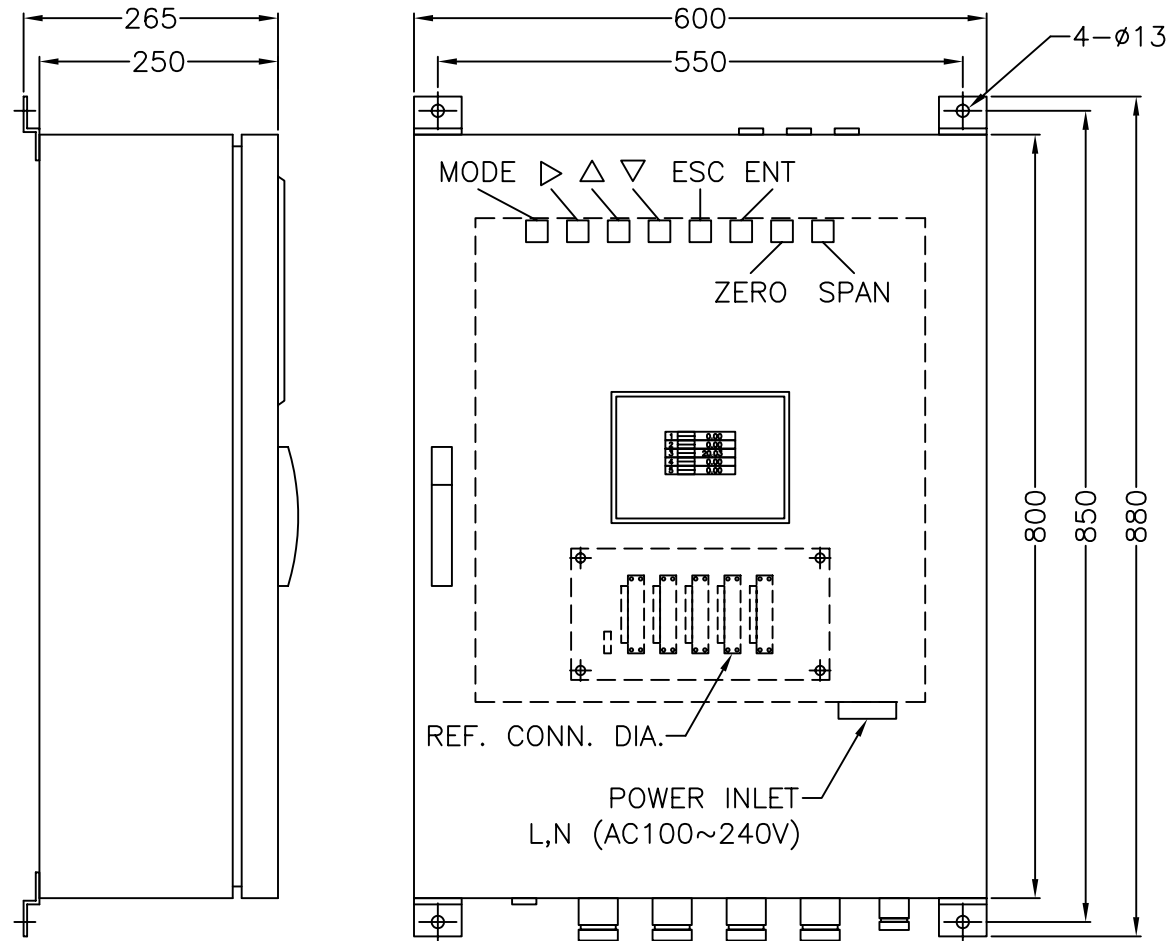

DO NOT SCALE DWG		THIS DRAWING IS THE PROPERTY OF TELEDYNE INSTRUMENTS AND CONTAINS CONFIDENTIAL INFORMATION. IT IS NOT TO BE COPIED, REPRODUCED OR USED WITHOUT WRITTEN PERMISSION.	
TOLERANCE UNLESS OTHERWISE SPECIFIED: ANGULAR ±1/2°		TELEDYNE INSTRUMENTS <i>Analytical Instruments</i> A Teledyne Technologies Company City of Industry, California, 91748, USA	
LINEAR { .X = ±.1 .XX = ±.02 .XXX = ±.010			
S/	SIGNATURES	DATE	TITLE OUTLINE DIAGRAM OF INFRARED ANALYZER (WALL MOUNT TYPE) 7500/7600 SERIES
N/	DRFT: K.MURALI	24/05/06	
I/	CHK:		
P/	APPR:		
O/	ENGR:		
F/	C.O.: PROPOSAL		SCALE NONE SIM SHEET 2 OF 2
REFERENCE	CAD I.D. BSK240506-2-0		
		MATEL. NONE	DWG NO. BSK-240506-2
			REV 0