OPERATING INSTRUCTIONS

Model 3010PAC

Percent Oxygen Analyzer

Flush Mount Control Unit, PN **D-66192B**
CENELEC Type Remote Probe, PN **B-39923C**
Intrinsic Safe Barriers Assy., PN **C-66426**



DANGER



HIGHLY TOXIC AND OR FLAMMABLE LIQUIDS OR GASES MAY BE PRESENT IN THIS MONITORING SYSTEM.

PERSONAL PROTECTIVE EQUIPMENT MAY BE REQUIRED WHEN SERVICING THIS SYSTEM.

HAZARDOUS VOLTAGES EXIST ON CERTAIN COMPONENTS INTERNALLY WHICH MAY PERSIST FOR A TIME EVEN AFTER THE POWER IS TURNED OFF AND DISCONNECTED.

ONLY AUTHORIZED PERSONNEL SHOULD CONDUCT MAINTENANCE AND/OR SERVICING. BEFORE CONDUCTING ANY MAINTENANCE OR SERVICING CONSULT WITH AUTHORIZED SUPERVISOR/MANAGER.

P/N M66395
08/06/99
ECO # 99-0323

Copyright © 1999 Teledyne Analytical Instruments

All Rights Reserved. No part of this manual may be reproduced, transmitted, transcribed, stored in a retrieval system, or translated into any other language or computer language in whole or in part, in any form or by any means, whether it be electronic, mechanical, magnetic, optical, manual, or otherwise, without the prior written consent of Teledyne Analytical Instruments, 16830 Chestnut Street, City of Industry, CA 91749-1580.

Warranty

This equipment is sold subject to the mutual agreement that it is warranted by us free from defects of material and of construction, and that our liability shall be limited to replacing or repairing at our factory (without charge, except for transportation), or at customer plant at our option, any material or construction in which defects become apparent within one year from the date of shipment, except in cases where quotations or acknowledgements provide for a shorter period. Components manufactured by others bear the warranty of their manufacturer. This warranty does not cover defects caused by wear, accident, misuse, neglect or repairs other than those performed by Teledyne or an authorized service center. We assume no liability for direct or indirect damages of any kind and the purchaser by the acceptance of the equipment will assume all liability for any damage which may result from its use or misuse.

We reserve the right to employ any suitable material in the manufacture of our apparatus, and to make any alterations in the dimensions, shape or weight of any parts, in so far as such alterations do not adversely affect our warranty.

Important Notice

This instrument provides measurement readings to its user, and serves as a tool by which valuable data can be gathered. The information provided by the instrument may assist the user in eliminating potential hazards caused by his process; however, it is essential that all personnel involved in the use of the instrument or its interface, with the process being measured, be properly trained in the process itself, as well as all instrumentation related to it.

The safety of personnel is ultimately the responsibility of those who control process conditions. While this instrument may be able to provide early warning of imminent danger, it has no control over process conditions, and it can be misused. In particular, any alarm or control systems installed must be tested and understood, both as to how they operate and as to how they can be defeated. Any safeguards required such as locks, labels, or redundancy, must be provided by the user or specifically requested of Teledyne at the time the order is placed.

Therefore, the purchaser must be aware of the hazardous process conditions. The purchaser is responsible for the training of personnel, for providing hazard warning methods and instrumentation per the appropriate standards, and for ensuring that hazard warning devices and instrumentation are maintained and operated properly.

Analytical Instruments, the manufacturer of this instrument, cannot accept responsibility for conditions beyond its knowledge and control. No statement expressed or implied by this document or any information disseminated by the manufacturer or its agents, is to be construed as a warranty of adequate safety control under the user's process conditions.

Table of Contents

Specific Model Information iv

Preface v

Part I: Control Unit, Model PAC Part I: 1-1

Part II: Intrinsic Safe Barriers Part II: 1-1

 Remote Probe

Appendix A-1

Specific Model Information

The instrument for which this manual was supplied may incorporate one or more options not supplied in the standard instrument. Commonly available options are listed below, with check boxes. Any that are incorporated in the instrument for which this manual was supplied are indicated by a check mark in the box.

Instrument Serial Number: _____

19" Rack Mount

The 19" Relay Rack Mount units are available with either one or two series 3010PAC analyzer Control Units installed in a standard 19" panel and ready to mount in a standard rack. See *Appendix* for details.

Cell Class* _____ (B-1 standard).

Enter Class Designation

* See *Part II, Chapter 2* and/or any addendum that may be attached to this manual for cell specifications.

Preface

Overview

The Analytical Instruments Model 3010PAC Percent Oxygen Analyzer is a versatile microprocessor-based instrument for detecting oxygen in a variety of background gases. It is a “split architecture” instrument. This means that a general purpose Control Unit, designed for nonhazardous areas only, remotely controls a specially designed Analysis Unit, or remote probe, that can operate in a hazardous area.

Part I of this manual covers the Model 3010PAC General Purpose flush-panel and/or rack-mount Control Unit only. This Control Unit is for indoor use in a nonhazardous environment. The Analysis Units (or Remote Probes) they control, can be designed for a variety of hazardous environments. Part II of this manual covers the 3010PAC Analysis Unit.

Typical Applications

A few typical applications of the Model 3010PAC are:

- Monitoring inert gas blanketing
- Air separation and liquefaction
- Chemical reaction monitoring
- Semiconductor manufacturing
- Petrochemical process control
- Quality assurance
- Gas analysis certification.

Model and Part Number Designations

The part numbers are the most specific identification. When using this manual for operation, maintenance, or ordering parts, check the part numbers on your Instruments to be sure of a match. Where an underscore (_) appears in a model number, the unit has more than one application. For example, 3010P_C means that the same unit is part of the 3010PAC and the 3010PBC models.

3010TA: NEC Type Trace Oxygen Analyzer with flush mount Control Unit. Consists of 3010TA Control Unit, **PN D-64596A** and a 3010T Analysis Unit, **PN D-65478**.

3010PA: NEC Type Percent Oxygen Analyzer with flush mount Control Unit. Consists of 3010PA Control Unit, **PN D-64596B or C** and a 3010P Analysis Unit, **PN D-65479**.

3010TB: NEC type Trace Oxygen Analyzer with bulkhead mount Control Unit. Consists of 3010TB/PB Control Unit, **PN D-66190A**, and a 3010T Analysis Unit, **PN D-65478**.

3010PB: NEC type Percent Oxygen Analyzer with bulkhead mount Control Unit. Consists of 3010TB Control Unit, **PN D-66190 B or C**, and a 3010T Analysis Unit, **PN D-65479**.

3010TAC: CENELEC type Trace Oxygen Analyzer with flush mount Control Unit. Consists of 3010TA Control Unit, **PN D-66192A**, and a 3010T_C Analysis Unit, **PN C-66336**

3010PAC: CENELEC type Percent Oxygen Analyzer with flush mount Control Unit. Consists of 3010PA Control Unit, **PN D-66192 B or C**, and a 3010P_C Analysis Unit, **PN B-39923C**

3010TBC: CENELEC type Trace Oxygen Analyzer with bulkhead mount Control Unit. Consists of 3010TB Control Unit, **PN D-66194A**, and a 3010T_C Analysis Unit, **PN C-66336**

3010PBC: CENELEC type Percent Oxygen Analyzer with bulkhead mount Control Unit. Consists of 3010PB Control Unit, **PN D-66194 B or C**, and a 3010P_C Analysis Unit, **PN B-39923C**

Options: See *Specific Model Information* sheet, on page *iv* for details.

Main Features of the Analyzer

The Model 3010PAC series Oxygen Analyzers are sophisticated yet simple to use. The main features of these analyzers include:

- A 2-line alphanumeric display screen, driven by microprocessor electronics, that continuously prompts and informs the operator.
- High resolution, accurate readings of oxygen content: from low 0-1 % levels through 0-100 %. Large, bright, meter readout.
- Optional stainless steel cell block available.
- Advance design Micro-Fuel Cell sensor with a one year warranty and an expected lifetime of two years.
- Versatile analysis over a wide range of applications.
- Microprocessor based electronics: 8-bit CMOS microprocessor with 32 kB RAM and 128 kB ROM.
- Three user definable output ranges allow best match to users process and equipment: 0-1 % through 0-100 %.
- Air-calibration range for convenient spanning at 20.9 %.
- Auto Ranging allows analyzer to automatically select the proper preset range for a given measurement. Manual override allows the user to lock onto a specific range of interest.
- Two adjustable concentration alarms and a system failure alarm.
- Self-diagnostic testing, at startup and on demand, with continuous power-supply monitoring.
- Two way RFI protection.
- RS-232 serial digital port for use with a computer or other digital communications device.
- Analog outputs for Concentration and Analysis Range: 0–1 V dc standard. Additional isolated 4–20 mA dc optional.
- Compact and versatile design: flush-panel, rack-mountable, or bulkhead mounted Control Units available.

Model 3010PAC complies with all of the requirements of the Commonwealth of Europe (CE) for Radio Frequency Interference, Electromagnetic Interference (RFI/EMI), and Low Voltage Directive (LVD).

The Analysis Unit is Intrinsically safe and CENELEC approved. The Control Unit is suitable for general purpose areas. The probe is CENELEC approved (certification code EEXIA IICT6).

The following International Symbols are used throughout the Instruction Manual for your visual and immediate warnings and when you have to attend CAUTION while operating the instrument:



STAND-BY, Instrument is on Stand-by, but circuit is active



GROUND
Protective Earth



CAUTION, The operator needs to refer to the manual for further information. Failure to do so may compromise the safe operation of the equipment.



CAUTION, Risk of Electric Shock

OPERATING INSTRUCTIONS

Models 3010PAC

Oxygen Analyzer

Part I Control Unit

Flush Mount

Part Number: D-66192B

Table of Contents

1 Introduction

| | |
|--|-----|
| 1.1 Overview | 1-1 |
| 1.2 Control Unit Front Panel | 1-1 |
| 1.3 Recognizing Difference Between LCD & VFD | 1-3 |
| 1.4 Control Unit Rear Panel | 1-3 |

2 Operational Theory

| | |
|---|-----|
| 2.1 Introduction | 2-1 |
| 2.2 Electronics and Signal Processing | 2-1 |

3 Installation

| | |
|--|------|
| 3.1 Unpacking the Control Unit | 3-1 |
| 3.2 Mounting the Control Unit | 3-1 |
| 3.3 Electrical Connections | 3-3 |
| 3.3.1 Primary Input Power | 3-4 |
| 3.3.2 50-Pin Interface Connector | 3-4 |
| 3.3.3 RS-232 Port | 3-9 |
| 3.3.4 Remote Probe Connection | 3-10 |
| 3.4 Testing the System | 3-11 |

4 Operation

| | |
|---|-----|
| 4.1 Introduction | 4-1 |
| 4.2 Using the Data Entry and Function Buttons | 4-2 |
| 4.3 The <i>System</i> Function | 4-3 |
| 4.3.1 Setting Display | 4-4 |
| 4.3.2 Setting up an Auto-Cal | 4-5 |
| 4.3.3 Password Protection | 4-5 |
| 4.3.3.1 Entering the Password | 4-6 |
| 4.3.3.2 Installing or Changing the Password | 4-7 |

| | | |
|---------|--|------|
| 4.3.4 | Logout | 4-8 |
| 4.3.5 | System Self-Diagnostic Test | 4-9 |
| 4.3.6 | Version Screen | 4-10 |
| 4.4 | The <i>Span</i> Functions | 4-10 |
| 4.4.1 | Cell Failurel | 4-10 |
| 4.4.2 | Span Cal | 4-11 |
| 4.4.2.1 | Auto Mode Spanning | 4-11 |
| 4.4.2.2 | Manual Mode Spanning | 4-12 |
| 4.5 | The <i>Alarms</i> Function | 4-13 |
| 4.6 | The <i>Range</i> Function | 4-15 |
| 4.6.1 | Setting the Analog Output Ranges | 4-15 |
| 4.6.2 | Fixed Range Analysis | 4-16 |
| 4.7 | The <i>Analyze</i> Function | 4-17 |
| 4.8 | Signal Output | 4-17 |

5 Maintenance

| | | |
|-----|-----------------------------------|-----|
| 5.1 | Fuse Replacement | 5-1 |
| 5.2 | System Self Diagnostic Test | 5-2 |
| 5.3 | Major Internal Components | 5-3 |
| 5.4 | Cleaning | 5-4 |

Model 3010PAC Oxygen Analyzer

Introduction

1.1 Overview

The Analytical Instruments Model 3010PAC Analyzer Control Unit, together with a 3010PAC Analysis Unit, is a versatile microprocessor-based instrument for detecting percent amounts of oxygen in a variety of gases.

Part I, this part, of this manual covers the Model 3010PAC series General Purpose flush-panel and/or rack-mount Control Units. (The Analysis Unit is covered in Part II of this manual.) The Control Unit is for indoor use in a nonhazardous environment only. The Analysis Units (or Remote Probes) it controls can be designed for a variety of hazardous environments.

1.2 Control Unit Front Panel

The standard 3010PAC Control Unit is housed in a rugged metal case with all remote controls and displays accessible from the front panel. See Figure 1-1. The front panel has a digital meter, an alphanumeric display, and thirteen buttons for operating the analyzer.

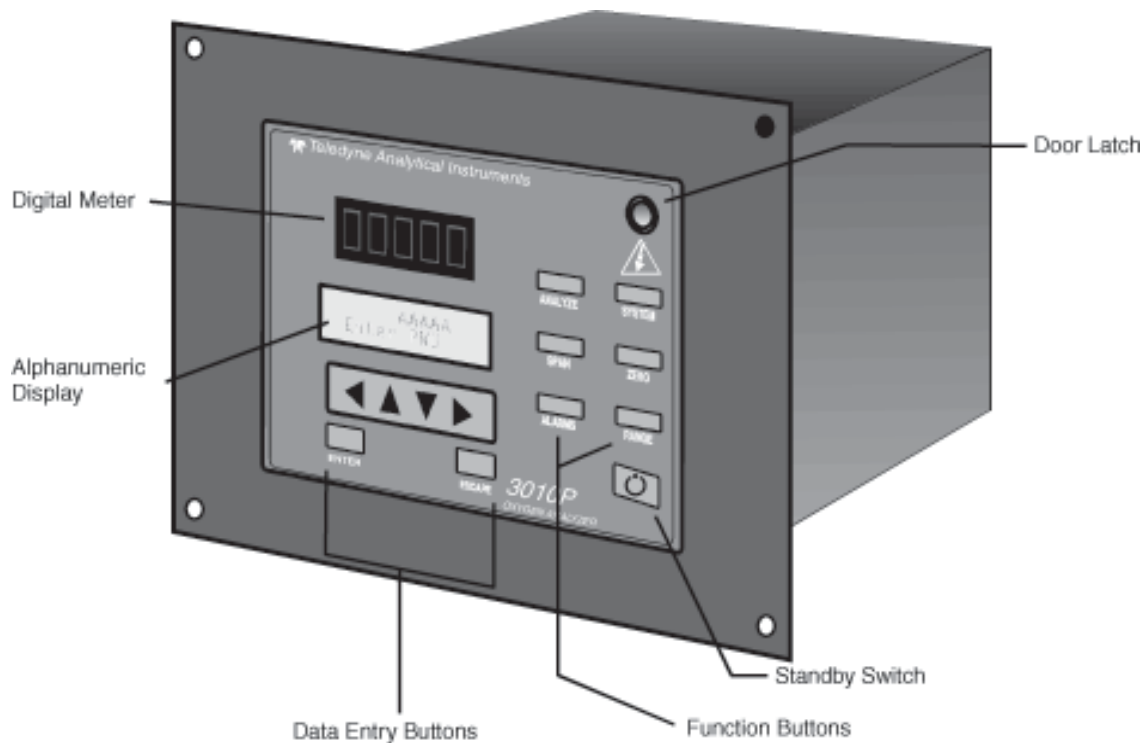

Figure 1-1: Front of Unmounted Control Unit

Function Keys: Six touch-sensitive membrane switches are used to change the specific function performed by the analyzer:

- **Analyze** Perform analysis for oxygen content of a sample gas.
- **System** Perform system-related tasks (described in detail in chapter 4, *Operation*).
- **Span** Span calibrate the analyzer.
- **Zero** Zero calibrate the analyzer.
- **Alarms** Set the alarm setpoints and attributes.
- **Range** Set up the 3 user definable ranges for the instrument.

Data Entry Keys: Six touch-sensitive membrane switches are used to input data to the instrument via the alphanumeric VFD display:

- **Left & Right Arrows** Select between functions currently displayed on the VFD screen.
- **Up & Down Arrows** Increment or decrement values of functions currently displayed.

- **Enter** Moves VFD display on to the next screen in a series. If none remains, returns to the *Analyze* screen.
- **Escape** Moves VFD display back to the previous screen in a series. If none remains, returns to the *Analyze* screen.

Digital Meter Display: The meter display is a LED device that produces large, bright, 7-segment numbers that are legible in any lighting. It is accurate across all analysis ranges from 0-1 % through 0-100 %

Alphanumeric Interface Screen: The backlit VFD screen is an easy-to-use interface between operator and analyzer. It displays values, options, and messages that give the operator immediate feedback.

 **Standby Button:** The red I/O button switches the instrument power between I (ON) and O (a Keep-Alive state). In the O state, the instrument's circuitry is operating, but there are no displays or outputs.

CAUTION: *The power cable must be unplugged to fully disconnect power from the instrument. When chassis is exposed or when access door is open and power cable is connected, use extra care to avoid contact with live electrical circuits .*



Access Door: For access to the front panel electronics, the front panel swings open when the latch in the upper right corner of the panel is pressed all the way in with a narrow gauge tool. Accessing the main circuit board and other electronics requires unfastening the rear panel screws and sliding the unit out of the case.

1.3 Recognizing Difference Between LCD & VFD

LCD has *GREEN* background with *BLACK* characters. VFD has *DARK* background with *GREEN* characters. In the case of VFD - *NO CONTRAST ADJUSTMENT IS NEEDED.*

1.4 Control Unit Rear Panel

The Control Unit rear panel, shown in Figure 1-2, contains the electrical connectors for external inputs and outputs. The input/output functions are described briefly here and in detail in the *Installation* chapter of this manual.

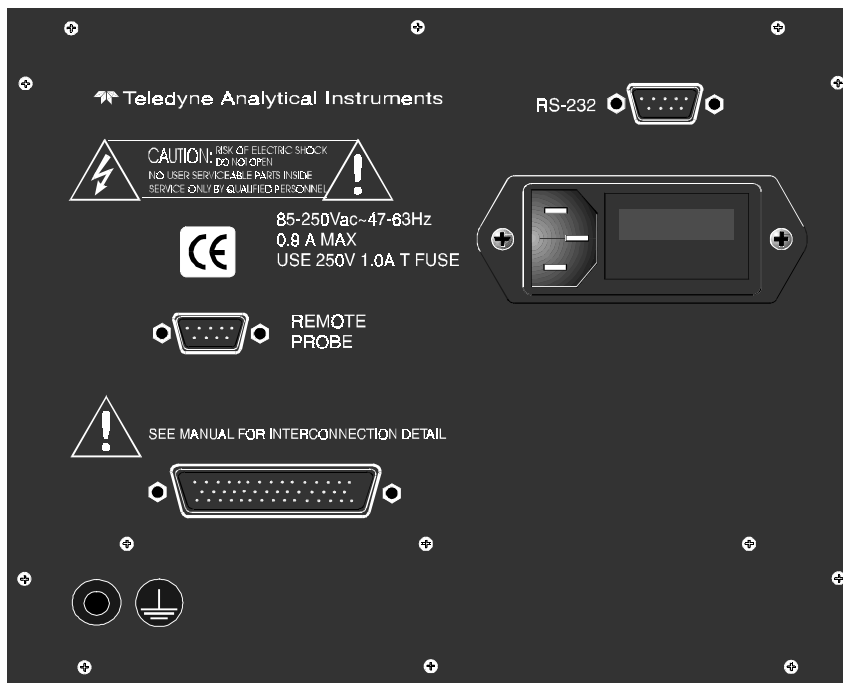

Figure 1-2: Model 3010PAC Rear Panel

- **Power Connection** Universal AC power source.
- **Analog Outputs** 0-1 V dc concentration and 0-1 V dc range ID. Optional isolated 4-20 mA dc and 4-20 mA dc range ID.
- **Alarm Connections** 2 concentration alarms and 1 system alarm.
- **RS-232 Port** Serial digital concentration signal output and control input.
- **Remote Probe** Provides all electrical interconnect to the Analysis Unit or Remote Probe.
- **Remote Span/Zero** Digital inputs allow external control of analyzer calibration.
- **Calibration Contact** To notify external equipment that instrument is being calibrated and readings are not monitoring sample.
- **Range ID Contacts** Four separate, dedicated, range relay contacts. Low, Medium, High, Cal.

- **Remote Probe** Interfaces with an Analysis Unit or Remote Probe (external sensor/sample system).
- **Network I/O** Serial digital communications for local network access. For future expansion. Not implemented at this printing.

Note: If you require highly accurate Auto-Cal timing, use external Auto-Cal control where possible. The internal clock in the Model 3010PAC is accurate to 2-3 %. Accordingly, internally scheduled calibrations can vary 2-3 % per day.

Operational Theory

2.1 Introduction

The Model 3010PAC Oxygen Analyzer Control Unit uses an 8031 microcontroller with 32 kB of RAM and 128 kB of ROM to control all signal processing, input/output, and display functions for the Model 3010PAC analyzer. (The sample system and Micro-Fuel Cell sensor are covered in Part II, *Analysis Unit*, in this manual.) System power is supplied from a universal power supply module designed to be compatible with any international power source.

2.2 Electronics and Signal Processing

All of the Analyzer electronics are located on Printed Circuit Board (PCB) assemblies inside the Control Unit chassis. The PCB locations are illustrated in section 5, *Maintenance*.

Refer to Figure 2-1, *Block Diagram of the 3010PAC CU Electronics*:

In the presence of oxygen, the sensor (in the Analysis Unit) generates a current. A current to voltage amplifier (in the Control Unit) converts this current to a voltage.

The second stage amplifier amplifies the voltage. It also uses a signal from the thermistor (which is physically located in the Analysis Unit cell block) to provide temperature compensation for the sensor signal. The thermistor is a temperature dependent resistance that changes the gain of the amplifier in proportion to the temperature changes in the block. This thermistor signal compensates for the change in the cell output due to the temperature changes. The result is a signal that is temperature independent. The output from the second stage amplifier is sent to an 18-bit analog to digital converter controlled by the microprocessor.

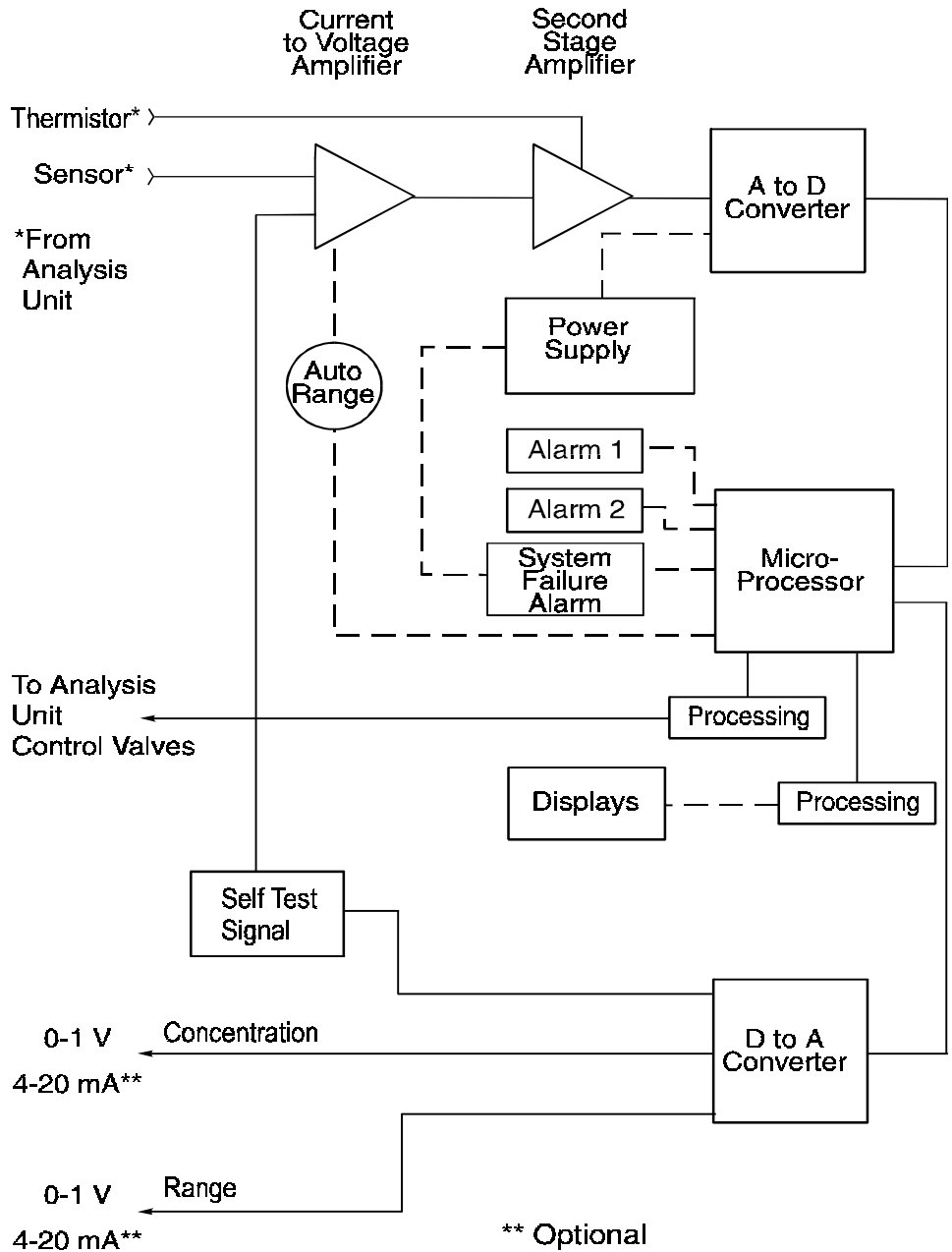

Figure 2-1: Block Diagram of the 3010PAC CU Electronics

The digital concentration signal—along with input from the control panel—is processed by the microprocessor, and appropriate control signals are directed to the display, alarms and communications port as well as to the optional gas control valves in the Analysis Unit.

The same digital information is also sent to a 12 bit digital to analog converter that produces the 0-1 V dc and the optional 4-20 mA dc analog concentration signal outputs, and the analog range ID outputs.

The microprocessor monitors the power supply, and activates the system failure alarm if a malfunction is detected.

Installation

Installation of Model 3010PAC Analyzers includes:

1. Unpacking, mounting, and interconnecting the Control Unit and the Analysis Unit
2. Making gas connections to the system
3. Making electrical connections to the system
4. Testing the system.

This chapter covers installation of the Control Unit. (Installation of the Analysis Unit is covered in Part II of this manual.)

3.1 Unpacking the Control Unit

The analyzer is shipped with all the materials you need to install and prepare the system for operation. Carefully unpack the Control Unit and inspect it for damage. Immediately report any damage to the shipping agent.

3.2 Mounting the Control Unit

The Model 3010PAC Control Unit is for indoor use in a general purpose area. It is NOT for hazardous environments of any type.

The standard model is designed for flush panel mounting. Figure 3-1 is an illustration of a Model 3010PAC standard Control Unit front panel and mounting bezel. There are four mounting holes—one in each corner of the rigid frame. Drawing number D-64596, at the back of this manual, contains a panel cutout diagram.

On special order, a 19" rack-mounting can be provided. Per order, one or two 3010PAC series Control Units are flush-panel mounted on the 19" rack panel. See Figure 3-2.

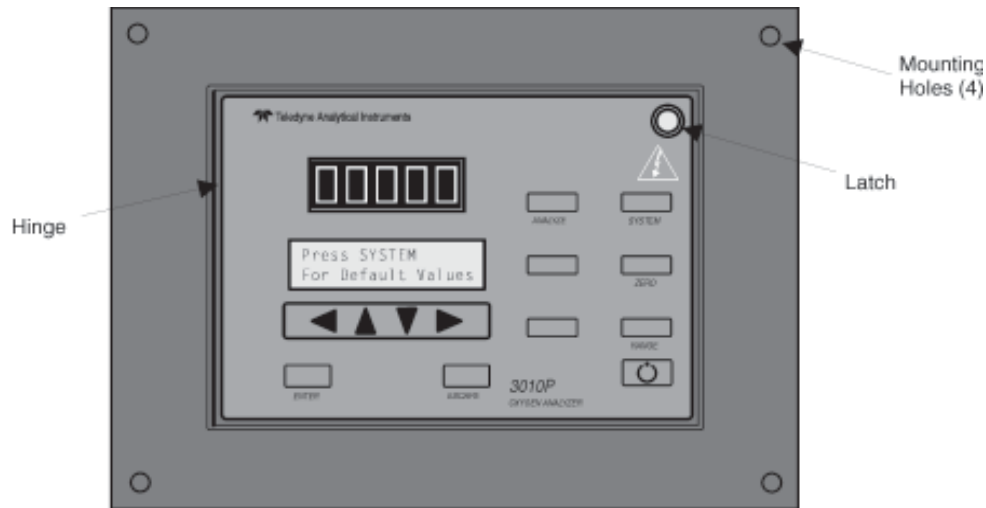

Figure 3-1: Front Panel of the Model 3010 Control Unit



Figure 3-2: Single and Dual 19" Rack Mounts

All operator controls are mounted on the control panel, which is hinged on the left edge and doubles as a door to provide access to the internal components of the instrument. The door is spring loaded and will swing open when the button in the center of the latch (upper right corner)

is pressed all the way in with a narrow gauge tool (less than 0.18 inch wide), such as a small hex wrench or screwdriver. Allow clearance for the door to open in a 90-degree arc of radius 7.625 inches. See Figure 3-3.

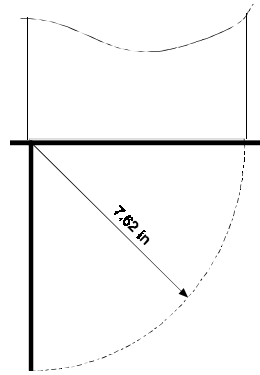

Figure 3-3: Required Front Door Clearance

3.3 Electrical Connections

Figure 3-4 shows the Control Unit rear panel. Connections for power, communications, and both digital and analog signal outputs are described in the following paragraphs. Wire size and maximum length data appear in the Drawings in the back of this manual.

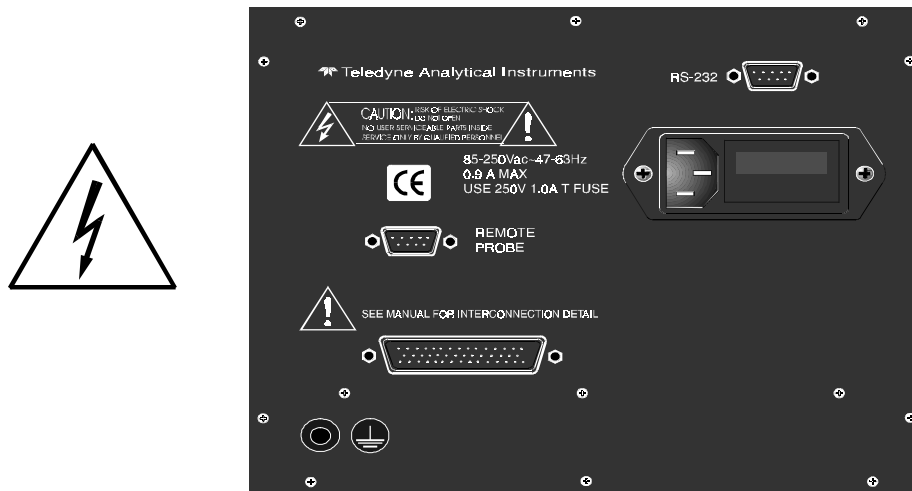

Figure 3-4: Rear Panel of the Model 3010PAC Control Unit

For safe connections, no uninsulated wiring should be able to come in contact with fingers, tools or clothing during normal operation.

CAUTION: *Use Shielded Cables. Also, use plugs that provide excellent EMI/RFI protection. The plug case must be connected to the cable shield, and it must be tightly fastened to the analyzer with its fastening screws. Ultimately, it is the installer who ensures that the connections provide adequate EMI/RFI shielding.*



3.3.1 Primary Input Power

The universal power supply requires a 85–250 V ac, 47–63 Hz power source. The power cord receptacle and fuse block are located in the same assembly. Insert the female plug end of the power cord into the power cord receptacle.

CAUTION: *Power is applied to the instrument's circuitry as long as the instrument is connected to the power source. The  switch on the front panel is for switching power on or off to the displays and outputs only.*

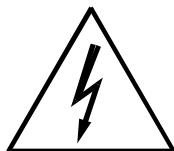

Fuse Installation: The fuse block, at the right of the power cord receptacle, accepts US or European size fuses. A jumper replaces the fuse in whichever fuse receptacle is not used. Fuses are not installed at the factory. Be sure to install the proper fuse as part of installation. (See *Fuse Replacement* in chapter 5, *maintenance*.)

3.3.2 50-Pin Equipment Interface Connector

Figure 3-4 shows the pin layout of the Equipment Interface connector. The arrangement is shown as seen when the viewer faces the rear panel of the analyzer. The pin numbers for each input/output function are given where each function is described in the paragraphs below.

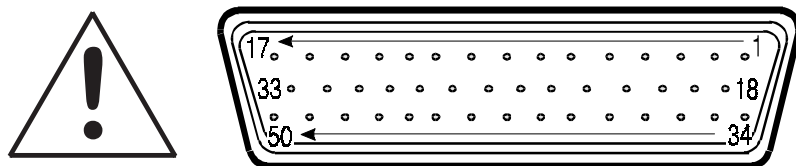

Figure 3-4: Equipment Interface Connector Pin Arrangement

Analog Outputs: There are four DC output signal pins—two pins per output. For polarity, see Table 3-1. The outputs are:



- 0–1 V dc % of Range: Voltage rises linearly with increasing oxygen, from 0 V at 0 ppm to 1 V at full scale ppm. (Full scale = 100% of programmable range.)
- 0–1 V dc Range ID: 0.25 V = Low Range, 0.5 V = Medium Range, 0.75 V = High Range, 1 V = Air Cal Range.
- 4–20 mA dc % Range: Current increases linearly with increasing oxygen, from 4 mA at 0 ppm to 20 mA at full scale ppm. (Full scale = 100% of programmable range.)
- 4–20 mA dc Range ID: 8 mA = Low Range, 12 mA = Medium Range, 16 mA = High Range, 20 mA = Air Cal Range.

Table 3-1: Analog Output Connections

| Pin | Function |
|-----|---------------------------------------|
| 3 | + Range ID, 4-20 mA, floating |
| 4 | – Range ID, 4-20 mA, floating |
| 5 | + % Range, 4-20 mA, floating |
| 6 | – % Range, 4-20 mA, floating |
| 8 | + Range ID, 0-1 V dc |
| 23 | – Range ID, 0-1 V dc, negative ground |
| 24 | + % Range, 0-1 V dc |
| 7 | – % Range, 0-1 V dc, negative ground |

Alarm Relays: The three alarm-circuit connectors are spring terminals for making connections to internal alarm relay contacts. Each provides a set of Form C contacts for each type of alarm. Each has both normally open and normally closed contact connections. The contact connections are indicated by diagrams on the rear panel. They are capable of switching up to 3 amperes at 250 V ac into a resistive load. See Figure 3-6. The connectors are:

- Threshold Alarm 1:
- Can be configured as high (actuates when concentration is above threshold), or low (actuates when concentration is below threshold).
 - Can be configured as failsafe or nonfailsafe.
 - Can be configured as latching or nonlatching.
 - Can be configured out (defeated).
- Threshold Alarm 2:
- Can be configured as high (actuates when concentration is above threshold), or low (actuates when concentration is below threshold).

- Can be configured as failsafe or nonfailsafe.
 - Can be configured as latching or nonlatching.
 - Can be configured out (defeated).
- System Alarm: Actuates when DC power supplied to circuits is unacceptable in one or more parameters. Permanently configured as failsafe and latching. Cannot be defeated. Actuates if self test fails.
- (Reset by pressing  button to remove power. Then press  again and any other button EXCEPT *System* to resume.

Further detail can be found in chapter 4, section 4-5.

Table 3-2: Alarm Relay Contact Pins

Pin Contact

| | |
|----|--|
| 45 | Threshold Alarm 1, normally closed contact |
| 28 | Threshold Alarm 1, moving contact |
| 46 | Threshold Alarm 1, normally open contact |
| 42 | Threshold Alarm 2, normally closed contact |
| 44 | Threshold Alarm 2, moving contact |
| 43 | Threshold Alarm 2, normally open contact |
| 36 | System Alarm, normally closed contact |
| 20 | System Alarm, moving contact |
| 37 | System Alarm, normally open contact |

Digital Remote Cal Inputs: Accept 0 V (off) or 24 V dc (on) inputs for remote control of calibration. (See *Remote Calibration Protocol* below.) See Table 3-3 for pin connections.

Zero: Floating input. 5 to 24 V input across the + and – pins puts the analyzer into the *Zero* mode. Either side may be grounded at the source of the signal. 0 to 1 volt across the terminals allows *Zero* mode to terminate when done. A synchronous signal must open and close the external zero valve appropriately. See *Remote Probe Connector*. (The –C option internal valves operate automatically.)

Span: Floating input. 5 to 24 V input across the + and – pins puts the analyzer into the *Span* mode. Either side may be grounded at the source of the signal. 0 to 1 volt across the terminals allows *Span* mode to terminate when done. A

synchronous signal must open and close external span valve appropriately. See Figure 3-5 *Remote Probe Connector*. (The –C option internal valves operate automatically.)

Cal Contact: This relay contact is closed while analyzer is spanning and/or zeroing. (See *Remote Calibration Protocol* below.)

Table 3-3: Remote Calibration Connections

| Pin | Function |
|-----|---------------|
| 9 | + Remote Zero |
| 11 | – Remote Zero |
| 10 | + Remote Span |
| 12 | – Remote Span |
| 40 | Cal Contact |
| 41 | Cal Contact |

Remote Calibration Protocol: To properly time the Digital Remote Cal Inputs to the Model 3010PAC Analyzer, the customer's controller must monitor the Cal Relay Contact.

When the contact is OPEN, the analyzer is analyzing, the Remote Cal Inputs are being polled, and a zero or span command can be sent.

When the contact is CLOSED, the analyzer is already calibrating. It will ignore your request to calibrate, and it will not remember that request.

Once a zero or span command is sent, and acknowledged (contact closes), release it. If the command is continued until after the zero or span is complete, the calibration will repeat and the Cal Relay Contact (CRC) will close again.

For example:

- 1) Test the CRC. When the CRC is open, Send a zero command until the CRC closes (The CRC will quickly close.)
- 2) When the CRC closes, remove the zero command.
- 3) When CRC opens again, send a span command until the CRC closes. (The CRC will quickly close.)
- 4) When the CRC closes, remove the span command.

When CRC opens again, zero and span are done, and the sample is being analyzed.

Note: The Remote Valve connections (described below) provides signals to ensure that the zero and span gas valves will be controlled synchronously. If you have the –C Internal valve

option—which includes additional zero and span gas inputs—the 3000PAC automatically regulates the zero, span and sample gas flow.

Range ID Relays: Four dedicated Range ID relay contacts. The first three ranges are assigned to relays in ascending order—Low range is assigned to Range 1 ID, Medium range is assigned to Range 2 ID, and High range is assigned to Range 3 ID. The fourth range is reserved for the Air Cal Range (25%).

Table 3-4 lists the pin connections.

Table 3-4: Range ID Relay Connections

| Pin | Function |
|-----|------------------------------|
| 21 | Range 1 ID Contact |
| 38 | Range 1 ID Contact |
| 22 | Range 2 ID Contact |
| 39 | Range 2 ID Contact |
| 19 | Range 3 ID Contact |
| 18 | Range 3 ID Contact |
| 34 | Range 4 ID Contact (Air Cal) |
| 35 | Range 4 ID Contact (Air Cal) |

Network I/O: A serial digital input/output for local network protocol. At this printing, this port is not yet functional. It is to be used for future options to the instrument. Pins 13 (+) and 29 (-).

Remote Valve Connections: The 3010PAC is a single-chassis instrument, which has no Remote Valve Unit. Instead, the Remote Valve connections are used as a method for directly controlling external sample/zero/span gas valves. See Figure 3-5.

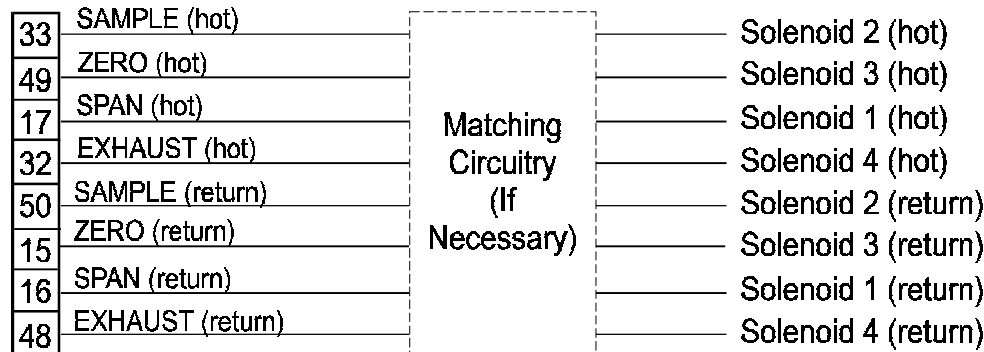

Figure 3-5: Remote Probe Connections

The voltage from these outputs is nominally 0 V for the OFF and 15 V dc for the ON conditions. The maximum combined current that can be pulled from these output lines is 100 mA. (If two lines are ON at the same time, each must be limited to 50 mA, etc.) If more current and/or a different voltage is required, use a relay, power amplifier, or other matching circuitry to provide the actual driving current.

In addition, each individual line has a series FET with a nominal ON resistance of 5 ohms (9 ohms worst case). This can limit the obtainable voltage, depending on the load impedance applied. See Figure 3-6.

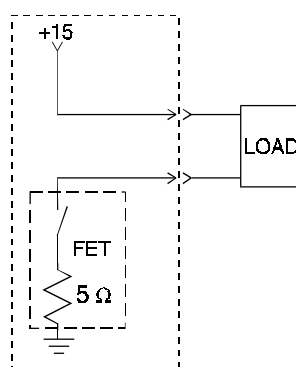

Figure 3-6: FET Series Resistance

3.3.3 RS-232 Port

The digital signal output is a standard, full duplex RS-232 serial communications port used to connect the analyzer to a computer, terminal, or other digital device. It requires a standard 9-pin D connector.

The output data is status information, in digital form, updated every two seconds. Status is reported in the following order:

- The concentration in ppm or percent
- The range in use (HI, MED, LO)
- The span of the range (0-100 ppm, etc)
- Which alarms—if any—are disabled (AL-x DISABLED)
- Which alarms—if any—are tripped (AL-x ON).

Each status output is followed by a carriage return and line feed.

Three input functions using RS-232 have been implemented to date. They are described in Table 3-5.

Table 3-5: Commands via RS-232 Input

| Command | Description |
|-------------------|--|
| as <enter> | Immediately starts an autospan. |
| az <enter> | Immediately starts an autozero. |
| st <enter> | Toggling input. Stops/Starts any status message output from the RS-232, until st <enter> is sent again. |

The RS-232 protocol allows some flexibility in its implementation. Table 3-6 lists certain RS-232 values that are required by the 3010PAC implementation.

Table 3-6: Required RS-232 Options

| Parameter | Setting |
|------------------|-----------|
| Baud | 2400 |
| Byte | 8 bits |
| Parity | none |
| Stop Bits | 1 |
| Message Interval | 2 seconds |

3.3.4 Remote Probe Connection

The Models 3010PAC are split architecture (dual-chassis) instruments, which have a Remote Probe, or Analysis Unit. The remote probe is for receiving the oxygen sensor and thermistor signals. See Figure 3-7 for remote probe connection. The connections of the Analysis Unit are covered in detail in Part II, section 3.4, of this manual.

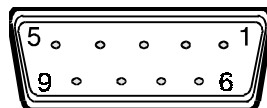

Remote Probe 9-pin Connector

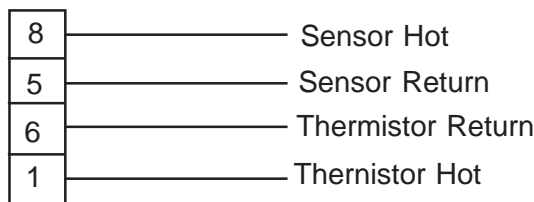

Figure 3-7: Remote Probe Interface Pinout Table 3-1:

CAUTION: *If you use your own control valves, or any other design, please be aware that the Intrinsic Safe requirements are provided. (See drawing D-66191 for wire recommendations).*



3.4 Testing the System

After The Control Unit and the Analysis Unit are **both** installed and interconnected, and the system gas and electrical connections are complete, the system is ready to test. **Before** plugging either of the units into their respective power sources:

- Check the integrity and accuracy of the gas connections. Make sure there are no leaks.
- Check the integrity and accuracy of all electrical connections. Make sure there are no exposed conductors

Power up the system, and test it by performing the following operations:

1. Repeat the Self-Diagnostic Test as described in chapter 4, section 4.3.5.

Operation

4.1 Introduction

Once the analyzer has been installed, configure it for your process. To do this you can:

- Set system parameters—
 - Specify a password, if desired, requiring operator to log in.
 - Establish and start an automatic calibration cycle, if desired.
- Calibrate the instrument.
- Define the three user selectable analysis ranges. Then choose autoranging or select a fixed range of analysis, as required.
- Set alarm setpoints, and modes (latching, failsafe, etc).

Before configuration these default values are in effect:

| PARAMETER | DEFAULT |
|---------------------|--|
| LO Range | 1 % |
| MED Range | 5 % |
| HI Range | 10 % |
| Auto Ranging | ON |
| Alarm Relays | 10 % (Defeated, HI, Not failsafe, Not latching) |
| Span | 20.9 % (Auto, every 0 days at 0 hours) |
| Zero | (Auto, every 0 days at 0 hours). |

If you choose not to use password protection, the default password is automatically displayed on the password screen when you start up, and you simply press *Enter* for access to all functions of the analyzer.

4.2 Using the Data Entry and Function Buttons

Data Entry Buttons: The < > arrow buttons select options from the menu currently being displayed on the VFD screen. The selected option blinks.

When the selected option includes a modifiable item, the $\Delta\nabla$ arrow buttons can be used to increment or decrement that modifiable item.

The *Enter* button is used to accept any new entries on the VFD screen. The *Escape* button is used to abort any new entries on the VFD screen that are not yet accepted by use of the *Enter* button.

Figure 4-1 shows the hierarchy of functions available to the operator via the function buttons. The six function buttons on the analyzer are:

- **Analyze.** This is the normal operating mode. The analyzer monitors the oxygen content of the sample, displays the concentration of oxygen, and warns of any alarm conditions.
- **System.** The system function consists of six subfunctions that regulate the internal operations of the analyzer:
 - LCD screen contrast **Contrast Function is *DISABLED*** (Refer to Section 1.3) 
 - Auto-Cal setup
 - Password assignment
 - Self-Test initiation
 - Checking software version
 - Logging out.
- **Zero.** Used to set up a zero calibration.
- **Span.** Used to set up a span calibration.
- **Alarms.** Used to set the alarm setpoints and determine whether each alarm will be active or defeated, HI or LO acting, latching, and/or failsafe.
- **Range.** Used to set up three analysis ranges that can be switched automatically with autoranging or used as individual fixed ranges.

Any function can be selected at any time by pressing the appropriate button (unless password restrictions apply). The order as presented in this manual is appropriate for an initial setup.

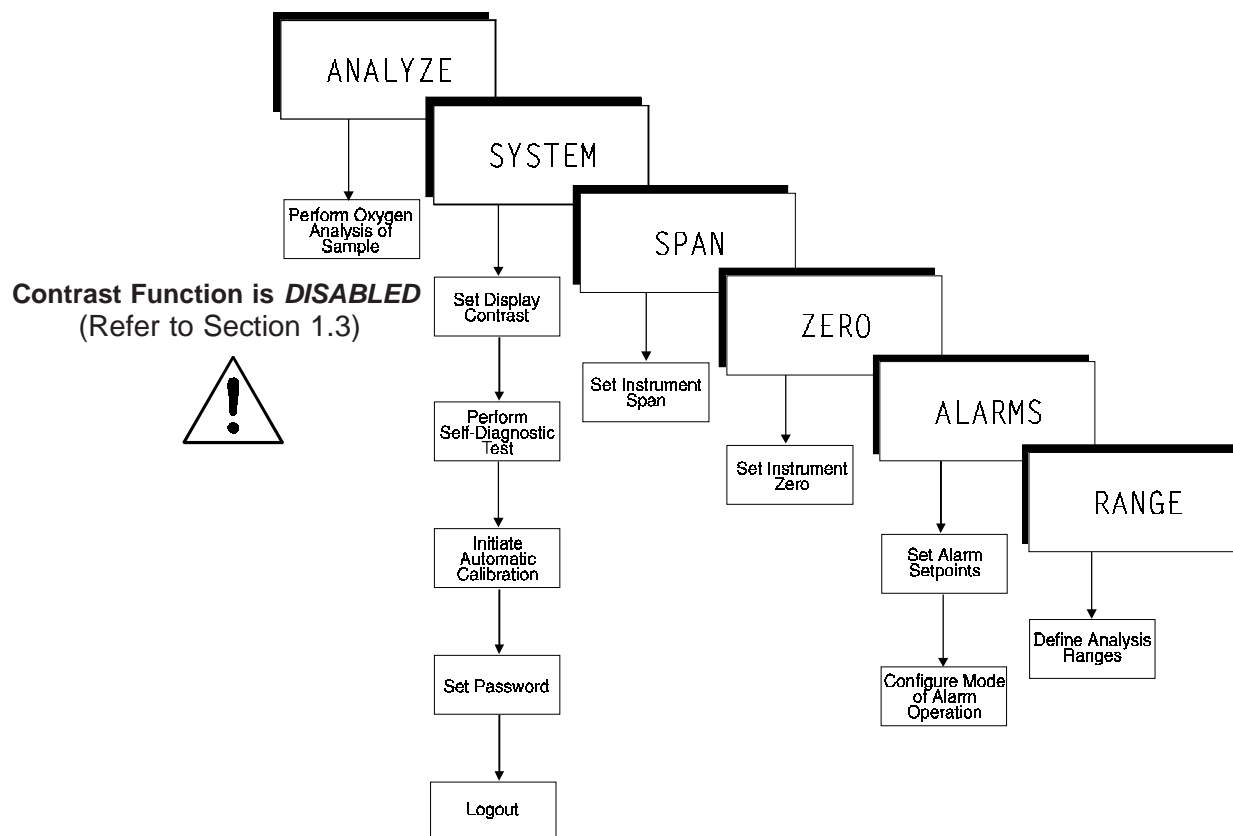

Figure 4-1: Hierarchy of Functions and Subfunctions

Each of these functions is described in greater detail in the following procedures. The VFD screen text that accompanies each operation is reproduced, at the appropriate point in the procedure, in a **Monospaced** type style. Pushbutton names are printed in *Oblique* type.

4.3 The System Function

The subfunctions of the *System* function are described below. Specific procedures for their use follow the descriptions:

- **Auto-Cal:** Used to define an automatic calibration sequence and/or start an Auto-Cal.
- **PSWD:** Security can be established by choosing a 5 digit password (PSWD) from the standard ASCII character set. (See *Installing or Changing a Password*, below, for a table of ASCII characters available.) Once a unique password is assigned and

activated, the operator **MUST** enter the **UNIQUE** password to gain access to set-up functions which alter the instrument's operation, such as setting the instrument span or zero setting, adjusting the alarm setpoints, or defining analysis ranges.

After a password is assigned, the operator must **log out** to activate it. Until then, anyone can continue to operate the instrument without entering the new password.

Only one password can be defined. Before a unique password is assigned, the system assigns TBEAI by default. This allows access to anyone. After a unique password is assigned, to defeat the security, the password must be changed back to TBEAI.

- **Logout:** Logging out prevents an unauthorized tampering with analyzer settings.
- **More:** Select and enter More to get a new screen with additional subfunctions listed.
- **Self-Test:** The instrument performs a self-diagnostic test to check the integrity of the power supply, output boards and amplifiers.
- **Version:** Displays Manufacturer, Model, and Software Version of instrument.

4.3.1 Setting the Display

Contrast Function is **DISABLED**
(Refer to Section 1.3)



If you cannot read anything on the display after first powering up:

1. Observe LED readout.
 - a. If LED meter reads all **eights and points**, go to step 3.
 - b. If LED meter displays anything else, go to step 2.
2. Press  button twice to turn Analyzer OFF and ON again. LED meter should now read all eights and periods.

4.3.2 Setting up an Auto-Cal

When the proper calibration gases are connected (see chapter 3, *installation*), the Analyzer can cycle itself through a sequence of steps that automatically zero and span the instrument.

Note: If you require highly accurate Auto-Cal timing, use external Auto-Cal control where possible. The internal clock in the Model 3010PAC is accurate to 2-3 %. Accordingly, internally scheduled calibrations can vary 2-3 % per day.

To setup an Auto-Cal cycle:

Choose *System* from the Function buttons. The LCD will display five subfunctions.



Contrast Function is DISABLED **Contrast Auto-Cal**
(Refer to Section 1.3) **PSWD Logout More**

Use < > arrows to blink Auto-Cal, and press *Enter*. A new screen for Span/Zero set appears.

Span OFF Nxt: 0d 0h
Zero OFF Nxt: 0d 0h

Press < > arrows to blink Span (or Zero), then press *Enter* again. (*You won't be able to set OFF to ON if a zero interval is entered.*) A Span Every ... (or Zero Every ...) screen appears.

Span Every 0 d
Start 0 h from now

Use $\Delta \nabla$ arrows to set an interval value, then use < > arrows to move to the start-time value. Use $\Delta \nabla$ arrows to set a start-time value.

To turn ON the Span and/or Zero cycles (to activate Auto-Cal): Press *System* again, choose Auto-Cal, and press *Enter* again. When the Span/Zero values screen appears, use the < > arrows to blink the Span (or Zero) OFF/ON field. Use $\Delta \nabla$ arrows to set the OFF/ON field to ON. You can now turn these fields ON because there is a nonzero span interval defined.

4.3.3 Password Protection

If a password is assigned, then setting the following system parameters can be done only after the password is entered: **span** and **zero** settings, **alarm** setpoints, analysis **range** definitions, switching between **autoranging** and manual override, setting up an **auto-cal**, and assigning a new **password**. However, the instrument can still be used for analysis or for initiating a self-test without entering the password.

If you have decided not to employ password security, use the default password TBEAI. This password will be displayed automatically by the microprocessor. The operator just presses the Enter key to be allowed total access to the instrument's features.

NOTE: If you use password security, it is advisable to keep a copy of the password in a separate, safe location.

4.3.3.1 Entering the Password

To install a new password or change a previously installed password, you must key in and *ENTER* the old password first. If the default password is in effect, pressing the *ENTER* button will enter the default TBEAI password for you.

Press *System* to enter the *System* mode.

**Contrast Auto-Cal
PSWD Logout More**

Contrast Function is *DISABLED*
(Refer to Section 1.3)



Use the < > arrow keys to scroll the blinking over to PSWD, and press *Enter* to select the password function. Either the default TBEAI password or AAAAA place holders for an existing password will appear on screen depending on whether or not a password has been previously installed.

T B E A I
Enter PWD

or

A A A A A
Enter PWD

The screen prompts you to enter the current password. If you are not using password protection, press *Enter* to accept TBEAI as the default password. If a password has been previously installed, enter the password using the < > arrow keys to scroll back and forth between letters, and the $\Delta \nabla$ arrow keys to change the letters to the proper password. Press *Enter* to enter the password.

If the password is accepted, the screen will indicate that the password restrictions have been removed and you have clearance to proceed.

PSWD Restrictions
Removed

In a few seconds, you will be given the opportunity to change this password or keep it and go on.

Change Password?**<ENT>=Yes <ESC>=No**

Press *Escape* to move on, or proceed as in *Changing the Password*, below.

4.3.3.2 Installing or Changing the Password

If you want to install a password, or change an existing password, proceed as above in *Entering the Password*. When you are given the opportunity to change the password:

Change Password?**<ENT>=Yes <ESC>=No**

Press *Enter* to change the password (either the default TBEAI or the previously assigned password), or press *Escape* to keep the existing password and move on.

If you chose *Enter* to change the password, the password assignment screen appears.

T B E A I**<ENT> To Proceed**or**A A A A A****<ENT> To Proceed**

Enter the password using the < > arrow keys to move back and forth between the existing password letters, and the Δ ∇ arrow keys to change the letters to the new password. The full set of 94 characters available for password use are shown in the table below.

Characters Available for Password Definition:

| | | | | | | | | | |
|---|---|---|---|---|----|---|---|---|---|
| A | B | C | D | E | F | G | H | I | J |
| K | L | M | N | O | P | Q | R | S | T |
| U | V | W | X | Y | Z | [| ¥ |] | ^ |
| _ | ` | a | b | c | d | e | f | g | h |
| i | j | k | l | m | n | o | p | q | r |
| s | t | u | v | w | x | y | z | { | |
| } | → | ! | " | # | \$ | % | & | ' | (|
|) | * | + | , | - | . | / | 0 | 1 | 2 |
| 3 | 4 | 5 | 6 | 7 | 8 | 9 | : | ; | < |
| = | > | ? | @ | | | | | | |

When you have finished typing the new password, press *Enter*. A verification screen appears. The screen will prompt you to retype your password for verification.

A A A A A
Retype PWD To Verify

Wait a moment. The entry screen will give you clearance to proceed.

A A A A A
<ENT> TO Proceed

Use the arrow keys to retype your password and press *Enter* when finished. Your password will be stored in the microprocessor and the system will immediately switch to the *Analyze* screen, and you now have access to all instrument functions.

If no alarms are tripped, the *Analyze* screen appears as:

0.0 % An1Z
Range: 0 – 100

If an alarm is tripped, the second line will change to show which alarm it is:

0.0 % An1z
AL-1

NOTE: If you previously logged off the system, you will now be required to re-enter the password to gain access to Span, Zero, Alarm, and Range functions.

4.3.4 Logout

The Logout function provides a convenient means of leaving the analyzer in a password protected mode without having to shut the instrument off. By entering Logout, you effectively log off the instrument leaving the system protected against use until the password is reentered. To log out, press the *System* button to enter the *System* function.

**Contrast Auto-Cal
PSWD Logout More**

Contrast Function is *DISABLED*
(Refer to Section 1.3)



Use the < > arrow keys to position the blinking over the Logout function, and press *Enter* to Log out. The screen will display the message:

**Protected Until
Password Reentered**

4.3.5 System Self-Diagnostic Test

The Model 3010PAC has a built-in self-diagnostic testing routine. Pre-programmed signals are sent through the power supply, output board and sensor circuit. The return signal is analyzed, and at the end of the test the status of each function is displayed on the screen, either as OK or as a number between 1 and 3. (See *System Self Diagnostic Test* in chapter 5 for number code.)

Note: Remote Probe connector must be connected to the Analysis Unit, or sensor circuit will not be properly checked.

The self diagnostics are run automatically by the analyzer whenever the instrument is turned on, but the test can also be run by the operator at will. To initiate a self diagnostic test during operation:

Press the *System* button to start the *System* function.



Contrast Function is *DISABLED* Contrast Auto-Cal
(Refer to Section 1.3) **PSWD Logout More**

Use the < > arrow keys to blink More, then press *Enter*.

Version Self-Test

Use the < > arrow keys again to move the blinking to the Self-Test function. The screen will follow the running of the diagnostic.

RUNNING DIAGNOSTIC
Testing Preamp – 83

During preamp testing there is a countdown in the lower right corner of the screen. When the testing is complete, the results are displayed.

Power: OK Analog: OK
Preamp: 3

The module is functioning properly if it is followed by OK. A number indicates a problem in a specific area of the instrument. Refer to chapter 5 *Maintenance* for number-code information. The results screen alternates for a time with:

Press Any Key
To Continue...

Then the analyzer returns to the initial System screen.

4.3.6 Version Screen

Move the < > arrow key to More and press *Enter*. With Version blinking, press *Enter*. The screen displays the manufacturer, model, and software version information.

4.4 The *Span* Functions

The analyzer is calibrated using span gas.

NOTE: *Zero is not necessary for Percent (%) level measurements.*

Additional information on Zero functions is provided in the Appendix A-5 of this manual.

Although the instrument can be spanned using air, a span gas with a known oxygen concentration in the range of 70–90% of full scale of the range of interest is recommended. Since the oxygen concentration in air is 20.9 %, the cell can take longer to recover if the instrument is used for very low levels, such as 1% full scale oxygen analysis, immediately following calibration in air.

Connect the calibration gases to the analyzer according to the instructions given in Section 3.4.1, *Gas Connections*, observing all the prescribed precautions.

If you are using password protection, you will need to enter your password to gain access to either of these functions. Follow the instructions in sections 4.3.3.2 or 4.3.3.3 to enter your password. Once you have gained clearance to proceed, you can enter the *Zero* or *Span* function.

4.4.1. Cell Failure

When the sensor in the 3010PAC begins to fail, the analyzer will usually require more and more frequent calibration. If the 3010PAC analysis readings drift downward uncharacteristically, try recalibration. If recalibration raises the readings temporarily, the cell may be failing.

You can check the output of the cell itself by going to the *System* function, selecting *More*, and pressing *Enter*. The cell output reading will be on the second line of the display.

Version Self-Test
Cell Output: ### μ A

The “good” reading depends on the class of cell your analyzer is using. Although the B-1 cell is standard in the 3010PAC, **check *Specific Model Information in the Front Matter in this manual for the class of cell you purchased.***

Then check *Cell Replacement* in Part II *Analysis Units*, chapter 5 *Maintenance*, and do the prescribed calculations. If a weak cell is indicated, replace the cell as described there in chapter 5.

4.4.2 Span Cal

The *Span* button on the front panel is used to span calibrate the analyzer. Span calibration can be performed using the **automatic** mode, where an internal algorithm compares consecutive readings from the sensor to determine when the output matches the span gas concentration. Span calibration can also be performed in **manual** mode, where the operator determines when the span concentration reading is acceptable and manually exits the function.

4.4.2.1 Auto Mode Spanning

Press *Span* to enter the span function. The screen that appears allows you to select whether the span calibration is to be performed automatically or manually. Use the $\Delta\nabla$ arrow keys to toggle between AUTO and MAN span settling. Stop when AUTO appears, blinking, on the display.

Span: Settling: AUTO
<ENT> For Next

Press *Enter* to move to the next screen.

Span Val: 20.90
<ENT>Span <UP>Mod #

Use the $\Delta\nabla$ arrow keys to enter the oxygen-concentration mode. Use the <> arrow keys to blink the digit you are going to modify. Use the $\Delta\nabla$ arrow keys again to change the value of the selected digit. When you have finished typing in the concentration of the span gas you are using (20.90 if you are using air), press *Enter* to begin the Span calibration.

% Span
Slope=#### ppm/s

The beginning span value is shown in the upper left corner of the display. As the span reading settles, the screen displays and updates informa-



tion on Slope. Spanning automatically ends when the span output corresponds, within tolerance, to the value of the span gas concentration. Then the instrument automatically returns to the analyze mode.

4.4.2.2 Manual Mode Spanning

Press *Span* to start the *Span* function. The screen that appears allows you to select whether the span calibration is to be performed automatically or manually.

Span: Settling:MAN
<ENT> For Next

Use the $\Delta\nabla$ keys to toggle between AUTO and MAN span settling. Stop when MAN appears, blinking, on the display. Press *Enter* to move to the next screen.

Span Val: 20.90
<ENT>Span <UP>Mod #

Press Δ (<UP>) to permit modification (Mod #) of span value.

Use the arrow keys to enter the oxygen concentration of the span gas you are using (20.90 if you are using air). The <> arrows choose the digit, and the $\Delta\nabla$ arrows choose the value of the digit.

Press *Enter* to enter the span value into the system and begin the span calibration.

Once the span has begun, the microprocessor samples the output at a predetermined rate. It calculates the difference between successive samplings and displays this difference as Slope on the screen. It takes several seconds for the first Slope value to display. Slope indicates rate of change of the Span reading. It is a sensitive indicator of stability.

% Span
Slope=#### ppm/s

When the Span value displayed on the screen is sufficiently stable, press *Enter*. (Generally, when the Span reading changes by 1 % or less of the full scale of the range being calibrated for a period of ten minutes it is sufficiently stable.) Once *Enter* is pressed, the Span reading changes to the correct value. The instrument then **automatically** enters the *Analyze* function.

4.5 The Alarms Function

The Model 3010PAC is equipped with 2 fully adjustable concentration alarms and a system failure alarm. Each alarm has a relay with a set of form C contacts rated for 3 amperes resistive load at 250 V ac. See figure in chapter 3, *Installation* and/or the Interconnection Diagram included at the back of this manual for relay terminal connections.

The system failure alarm has a fixed configuration described in chapter 3 *Installation*.

The concentration alarms can be configured from the front panel as either *high* or *low* alarms by the operator. The alarm modes can be set as *latching* or *nonlatching*, and either *failsafe* or *nonfailsafe*, or, they can be *defeated* altogether. The setpoints for the alarms are also established using this function.

Decide how your alarms should be configured. The choice will depend upon your process. Consider the following four points:

1. Which if any of the alarms are to be high alarms and which if any are to be low alarms?

Setting an alarm as HIGH triggers the alarm when the oxygen concentration rises above the setpoint. Setting an alarm as LOW triggers the alarm when the oxygen concentration falls below the setpoint.

Decide whether you want the alarms to be set as:

- Both high (high and high-high) alarms, or
- One high and one low alarm, or
- Both low (low and low-low) alarms.

2. Are either or both of the alarms to be configured as failsafe?

In failsafe mode, the alarm relay de-energizes in an alarm condition. For nonfailsafe operation, the relay is energized in an alarm condition. You can set either or both of the concentration alarms to operate in failsafe or nonfailsafe mode.

3. Are either of the alarms to be latching?

In latching mode, once the alarm or alarms trigger, they will remain in the alarm mode even if process conditions revert back to no-alarm conditions. This mode requires an alarm to be recognized before it can be reset. In the nonlatching mode, the alarm status will terminate when process conditions revert to no-alarm conditions.

4. Are either of the alarms to be defeated?

The defeat alarm mode is incorporated into the alarm circuit so that maintenance can be performed under conditions which would normally activate the alarms.

The defeat function can also be used to reset a latched alarm. (See procedures, below.)

If you are using password protection, you will need to enter your password to access the alarm functions. Follow the instructions in Section 4.3.3 to enter your password. Once you have clearance to proceed, enter the *Alarm* function.

Press the *Alarm* button on the front panel to enter the *Alarm* function. Make sure that AL-1 is blinking.

AL-1 AL-2
Choose Alarm

Set up alarm 1 by moving the blinking over to AL-1 using the < > arrow keys. Then press *Enter* to move to the next screen.

AL-1 10 % HI
Dft-N Fs-N Ltch-N

Five parameters can be changed on this screen:

- Value of the alarm setpoint, AL-1 ##### (% oxygen)
- Out-of-range direction, HI or LO
- Defeated? Dft-Y/N (Yes/No)
- Failsafe? Fs-Y/N (Yes/No)
- Latching? Ltch-Y/N (Yes/No).
- To define the setpoint, use the < > arrow keys to move the blinking over to AL-1 #####. Then use the Δ ∇ arrow keys to change the number. Holding down the key speeds up the incrementing or decrementing. (Remember, setpoint units are parts-per-million.)
- To set the other parameters use the < > arrow keys to move the blinking over to the desired parameter. Then use the Δ ∇ arrow keys to change the parameter.
- Once the parameters for alarm 1 have been set, press *Alarms* again, and repeat this procedure for alarm 2 (AL-2).
- To reset a latched alarm, go to Dft- and then press either Δ two times or ∇ two times. (Toggle it to Y and then back to N.)

-OR-

Go to Ltch- and then press either Δ two times or ∇ two times.
(Toggle it to **N** and back to **Y**.)

4.6 The *Range* Function

The Range function allows the operator to program up to three concentration ranges to correlate with the DC analog outputs. If no ranges are defined by the user, the instrument defaults to:

| Range | Limits |
|-------|---------|
| Low | 0–1 % |
| Med | 0–5 % |
| High | 0–10 %. |

The Model 3010PAC is set at the factory to default to autoranging. In this mode, the microprocessor automatically responds to concentration changes by switching ranges for optimum readout sensitivity. If the current range limits are exceeded, the instrument will automatically shift to the next higher range. If the concentration falls to below 85% of full scale of the next lower range, the instrument will switch to that range. A corresponding shift in the DC percent-of-range output, and in the range ID outputs, will be noticed.

The autoranging feature can be overridden so that analog output stays on a fixed range regardless of the oxygen concentration detected. If the concentration exceeds the upper limit of the range, the DC output will saturate at 1 V dc (20 mA at the current output).

However, the digital readout and the RS-232 output of the concentration are unaffected by the fixed range. They continue to read accurately with full precision. See *Front Panel* description in chapter 1.

The automatic air calibration range is always 0-25 % and is not programmable.

4.6.1 Setting the Analog Output Ranges

To set the ranges, enter the range function mode by pressing the *Range* button on the front panel.

```
L-###   M-####
H-#####  Mode-AUTO
```

Use the < > arrow keys to blink the range to be set: low (L), medium (M), or high (H).

Use the $\Delta\nabla$ arrow keys to enter the upper value of the range (all ranges begin at 0 %). Repeat for each range you want to set. Press *Enter* to accept the values and return to *Analyze* mode. (See note below.)

Note: The ranges must be increasing from low to high, for example, if range 1 is set for 0–10 % and range 2 is set for 0–100 %, range 3 cannot be set for 0–50 % since it is lower than range 2.

4.6.2 Fixed Range Analysis

The autoranging mode of the instrument can be overridden, forcing the analyzer DC outputs to stay in a single predetermined range.

To switch from autoranging to fixed range analysis, enter the range function by pressing the *Range* button on the front panel.

Use the < > arrow keys to move the blinking over AUTO.

Use the $\Delta\nabla$ arrow keys to switch from AUTO to FX/LO, FX/MED, or FX/HI to set the instrument on the desired fixed range (low, medium, or high).

L-### M-####
H-##### Mode-FX/LO

or

L-### M-####
H-##### Mode-FX/MED

or

L-### M-####
H-##### Mode-FX/HI

Press *Escape* to re-enter the *Analyze* mode using the fixed range.

NOTE: When performing analysis on a fixed range, if the oxygen concentration rises above the upper limit (or default value) as established by the operator for that particular range, the output saturates at 1 V dc (or 20 mA). However, the digital readout and the RS-232 output continue to read the true value of the oxygen concentration regardless of the analog output range.

4.7 The *Analyze* Function

When the *Analyze* function is active, the 3010PAC is monitoring the sample gas currently flowing in the Analysis Unit cell block. All undefeated alarms are ready to activate should their respective setpoints be crossed.

Press the *Analyze* button to put the analyzer in the *Analyze* mode.

Normally, all of the functions automatically switch back to the *Analyze* function when they have completed their assigned operations. Pressing the *Escape* button in many cases also switches the analyzer back to the *Analyze* function. Alternatively, you can press the *Analyze* button at any time to return to analyzing your sample.

4.8 Signal Output

The standard Model 3010PAC Oxygen Analyzer are equipped with two 0-1 V dc analog output terminals accessible on the back panel (one concentration and one range ID). Two isolated 4-20 mA dc current outputs (one concentration and one range ID), in addition to the voltage outputs, are optional.

See *Rear Panel* in chapter 3, *Installation*, for illustration.

The signal output for concentration is linear over the currently selected analysis range. For example, if the analyzer is set on range that was defined as 0–10 % O₂, then the output would be:

| % O ₂ | Voltage Signal Output (V dc) | Current Signal Output (mA dc) |
|------------------|------------------------------|-------------------------------|
| 0 | 0.0 | 4.0 |
| 1 | 0.1 | 5.6 |
| 2 | 0.2 | 7.2 |
| 3 | 0.3 | 8.8 |
| 4 | 0.4 | 10.4 |
| 5 | 0.5 | 12.0 |
| 6 | 0.6 | 13.6 |
| 7 | 0.7 | 15.2 |
| 8 | 0.8 | 16.8 |
| 9 | 0.9 | 18.4 |
| 10 | 1.0 | 20.0 |

Interpretation of the analog output signal depends on the voltage (or current) AND the currently activated analysis range. To relate the signal output to the actual concentration, it is necessary to know what range the instrument is currently on, especially when the analyzer is in the autoranging mode.

To provide an indication of the range, a second pair of analog output terminals are used. They generate a steady preset voltage (or current when using the current outputs) to represent a particular range. The following table gives the range ID output for each analysis range:

| Range | Voltage (V) | Current (mA) |
|--------------|--------------------|---------------------|
| LO | 0.25 | 8 |
| MED | 0.50 | 12 |
| HI | 0.75 | 16 |
| CAL (0-25%) | 1.00 | 20 |

Maintenance



Aside from normal cleaning and checking for leaks at the gas connections, routine maintenance is limited to replacing Micro-Fuel cells and fuses, and recalibration.



Checking for leaks, replacing Micro-Fuel cells, and replacing fuses in the Analysis Unit are covered in Part II, Chapter 5. For recalibration, see Part I, section 4.4 *Calibration*.

WARNING: SEE WARNINGS ON THE TITLE PAGE OF THIS MANUAL.

5.1 Fuse Replacement

1. Place small screwdriver in notch, and pry cover off, as shown in Figure 5-1.

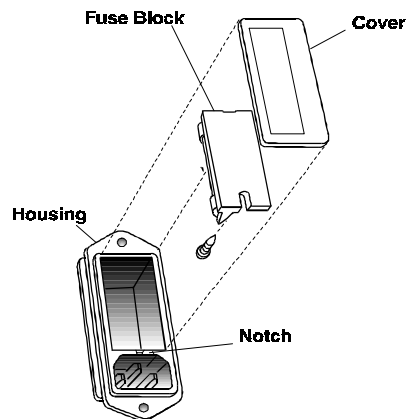

Figure 5-1: Removing Fuse Block from Housing

2. To change between American and European fuses, remove the single retaining screw, flip Fuse Block over 180 degrees, and replace screw.



3. Replace fuse as shown in Figure 5-2.
4. Reassemble Housing as shown in Figure 5-1.

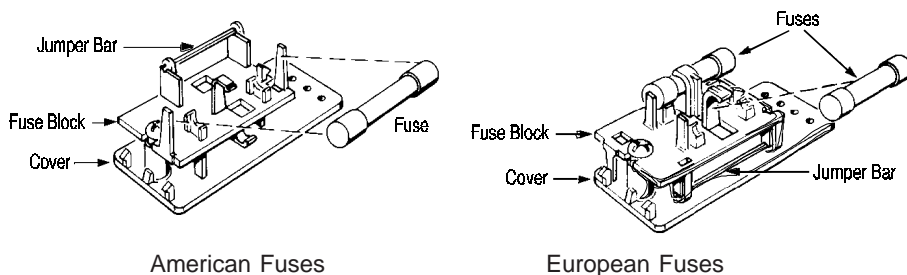

Figure 5-2: Installing Fuses

5.2 System Self Diagnostic Test

1. Press the *System* button to enter the system mode.
2. Use the < > arrow keys to move to *More*, and press *Enter*.
3. Use the < > arrow keys to move to *Self-Test*, and press *Enter*.

The following failure codes apply:

Table 5-1: Self Test Failure Codes

Power

| | |
|---|--------------|
| 0 | OK |
| 1 | 5 V Failure |
| 2 | 15 V Failure |
| 3 | Both Failed |

Analog

| | |
|---|-----------------------------|
| 0 | OK |
| 1 | DAC A (0–1 V Concentration) |
| 2 | DAC B (0–1 V Range ID) |
| 3 | Both Failed |

Preamp

| | |
|---|---|
| 0 | OK |
| 1 | Zero too high |
| 2 | Amplifier output doesn't match test input |
| 3 | Both Failed |

5.3 Major Internal Components

The major components in the Control Unit are shown in Figure 5-3.

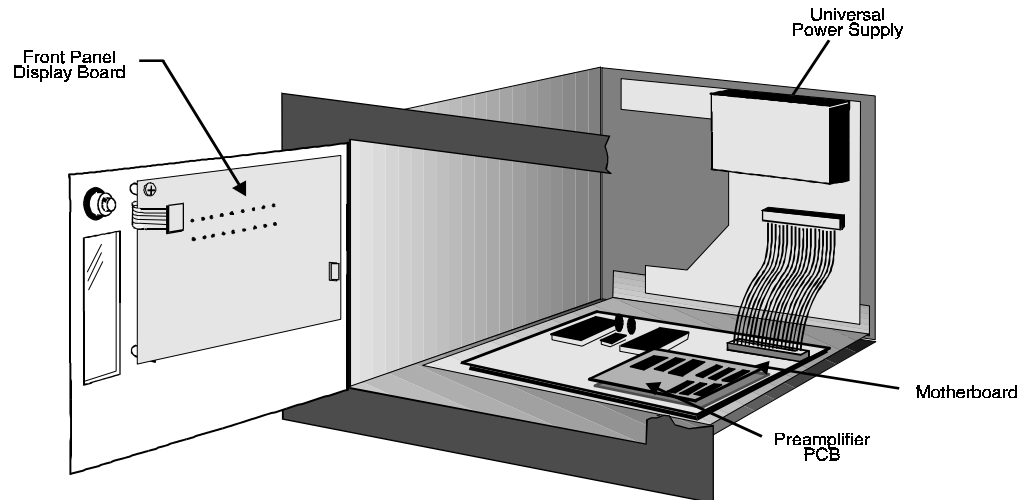
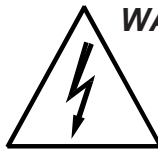

Figure 5-3: Control Unit Major Internal Components



WARNING: HAZARDOUS VOLTAGES EXIST ON CERTAIN COMPONENTS INTERNALLY WHICH MAY PERSIST FOR A TIME EVEN AFTER THE POWER IS TURNED OFF AND DISCONNECTED.

The 3010PAC Control Units contain the following major components:

- Power Supply
- Motherboard (with Microprocessor, RS-232 chip, and Preamplifier PCB)
- Front Panel Display Board and Displays—
 - 5 digit LED meter
 - 2 line, 20 character, alphanumeric, VFD display

See the drawings in the Drawings section in back of this manual for details.

The Front Panel Display Board is accessed by unlatching and swinging open the front panel, as described earlier. Other electronic components are accessed by removing four rear panel screws and sliding out the entire chassis. See Figure 5-4, below.

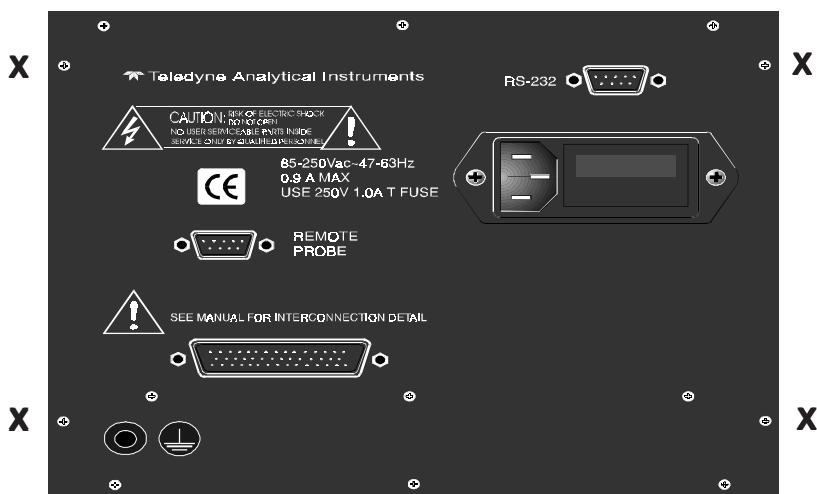

Figure 5-4: Rear-Panel Screws

To detach the rear panel, remove only those four screws marked with an X.

5.4 Cleaning

If instrument is unmounted at time of cleaning, disconnect the instrument from the power source. Close and latch the front-panel access door. Clean outside surfaces with a soft cloth dampened slightly with plain clean water. Do not use any harsh solvents such as paint thinner or benzine.

For panel-mounted instruments, clean the front panel as prescribed in the above paragraph. **DO NOT wipe front panel while the instrument is monitoring your process.**

OPERATING INSTRUCTIONS

Model 3010PAC

Oxygen Analyzer

Part II

Intrinsic Safe Barriers
and
Remote Probe

CENELEC Type

Part Number C-66426

Table of Contents

1 Introduction

| | |
|-----------------------------------|-----|
| 1.1 Overview | 1-1 |
| 1.2 Intrinsic Safe Barriers | 1-1 |
| 1.3 Area Classificationl | 1-2 |
| 1.4 Cell Housing/Probe | 1-2 |

2 Operational Theory

| | |
|--|-----|
| 2.1 Introduction | 2-1 |
| 2.2 Micro-Fuel Cell Sensors | 2-1 |
| 2.2.1 Principles of Operation | 2-1 |
| 2.2.2 Anatomy of a Micro-Fuel Cell | 2-2 |
| 2.2.3 Electrochemical Reactions | 2-3 |
| 2.2.4 The Effect of Pressure | 2-4 |
| 2.2.5 Calibration Characteristics | 2-4 |
| 2.2.6 Micro-Fuel Cell "Class" | 2-5 |
| 2.2.6.1 Class A-3 Cell | 2-5 |
| 2.2.6.2 Class A-5 Cell | 2-5 |
| 2.2.6.3 Class B-1 Cell | 2-6 |
| 2.2.6.4 Class B-3 Cell | 2-6 |
| 2.2.6.5 Class C-3 Cell | 2-6 |
| 2.2.6.6 Hydrogen and/or Helium Service | 2-6 |

3 Installation

| | |
|--|-----|
| 3.1 Unpacking the Analysis Unit | 3-1 |
| 3.2 Mounting the Analysis Unit | 3-1 |
| 3.3 Installing the Micro-Fuel Cell | 3-2 |
| 3.4 Testing the System | 3-2 |
| 3.5 Intrinsic Safety Barriers | 3-3 |
| 3.6 Remote Probe Connection | 3-5 |

4 Maintenance

| | |
|---------------------------------------|-----|
| 4.1 Routine Maintenance | 4-1 |
| 4.2 When to Replace a Cell | 4-1 |
| 4.3 Cell Warranty | 4-2 |
| 4.4 System Self Diagnostic Test | 4-3 |

Introduction

1.1 Overview

The Analytical Instruments Model 3010PAC Remote Probe is a versatile remotely controlled instrument for detecting percent amounts of oxygen (0-1% to 0-100%) in a variety of background gases. Details are recorded in *Specifications* in the Appendix to this manual.

The analyzer is designed to meet the CENELEC operation standards for European use. The analyzer uses a unique micro-fuel cell (MFC) to measure the concentration of oxygen in a gas stream. The instrument is composed of three separate units (cell housing) and safety barrier box - which may be widely separated physically and are intended for applications where remote control of the sample analysis is desirable.

Safety barrier box isolate the BASEEFA approved probes from the control unit. The intrinsically-safe sensor probe contains TAI's B1 sensor and temperature compensation components. The unit's feature percent oxygen (O₂) analysis in the ranges of 0-1 thru 0-100% and 0-25% CAL.

1.2 Intrinsic Safe Barriers

The intrinsically safe cell block houses the MFC and the temperature compensation thermistor.

Intrinsic safety barriers are used to limit the electrical energy within the controlled circuit to a level too low to cause ignition of a flammable material.

Any and all hazardous conditions to which the analyzer may be exposed are characteristic of the user's environment, and understanding of the conditions and precautions necessary for safe operation are user's responsibility.

CAUTION: *Bypassing the barriers in any way nullifies their effect, and conditions which prompted their use will prevail. If the instrument is used under any conditions contrary to the intrinsic safety design, the user assumes all risk.*



1.3 Area Classification

The control unit and barrier box are general purpose units and must be located in a non-hazardous location. The analysis unit, when installed with the safety barriers in accordance with drawing C66191, is CENELEC approved as intrinsically safe.

CAUTION: *The CENELEC approval as Intrinsically Safe requires that the instrument be properly installed with the included approved safety barriers (P/N B366 and P/N B367) and barrier box (P/N E324) as shown in drawing C66191.*



1.4 Cell Housing/Probe

The cell housing (probe) provides an enclosure for the B1 sensor and temperature-compensation thermistor.

The sensor is held in place by two contact springs and the cell cap. To remove the cell for replacement, three (3) wing nuts must first be removed and then the cell cap. After replacing the MFC in the cap, membrane side down (screen), the cap and three (3) wing nuts are replaced.

CAUTION: *Do not touch the silver/gold color sensing surface of the cell as it is covered with a delicate Teflon membrane that can be ruptured in handling.*



The gas inlet/outlet ports are Swagelock fittings that provide for the connection of 6mm tubing. Other various connections are available.

Electrical connections are made by a wire cable located at the top of the cell housing. (See the “Wiring Diagram” at the rear of this manual).

Operational Theory

2.1 Introduction

The Analysis Unit is composed of two subsystems: the Micro-Fuel Cell sensor and the sample system.

The Micro-Fuel Cell is an electrochemical galvanic device that translates the amount of oxygen present in the sample into an electrical current. The sample system is designed to accept the sample and calibration gasses, select between them (in response to Control Unit signals), and transport the gas through the analyzer—without contaminating or altering its composition before it reaches the sensor.

The electronic signal processing, display, and control systems are housed in the remote Control Unit, covered in Part I of this manual.

2.2 Micro-Fuel Cell Sensor

2.2.1 Principles of Operation

The oxygen sensors used in the Model 3010PAC series are Micro-Fuel Cells designed and manufactured by Analytical Instruments. They are sealed plastic disposable electrochemical transducers.

The active components of a Micro-Fuel Cell are the cathode, the anode, and the 15% aqueous KOH electrolyte in which they are immersed. The cell converts the energy from a chemical reaction into an electrical current in an external electrical circuit. Its action is similar to that of a battery.

There is, however, an important difference in the operation of a battery as compared to the Micro-Fuel Cell: In the battery, all reactants are stored within the cell, whereas in the Micro-Fuel Cell, one of the reactants (oxygen) comes from outside the device as a constituent of the sample gas

being analyzed. The Micro-Fuel Cell is therefore a hybrid between a battery and a true fuel cell. (All of the reactants are stored externally in a true fuel cell.)

2.2.2 Anatomy of a Micro-Fuel Cell

A Micro-Fuel Cell (MFC) is a cylinder only 1¼ inches in diameter and 1¼ inches thick. It is made of an extremely inert plastic, which can be placed confidently in practically any environment or sample stream. The cell is effectively sealed, although one end is permeable to oxygen in the sample gas. The other end of the cell is a contact plate consisting of two concentric foil rings. The rings mate with spring-loaded contacts in the sensor block assembly and provide the electrical connection to the rest of the analyzer. Figure 2-1 shows the external features of a typical cell.

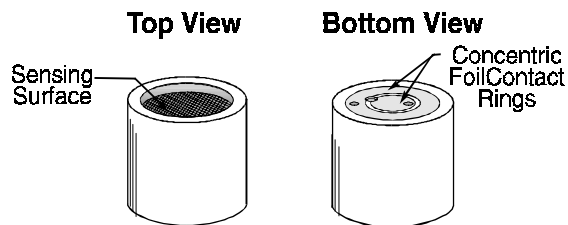

Figure 2-1: Micro-Fuel Cell

Refer to Figure 2-2, *Cross Section of a Micro-Fuel Cell*, which illustrates the following internal description.

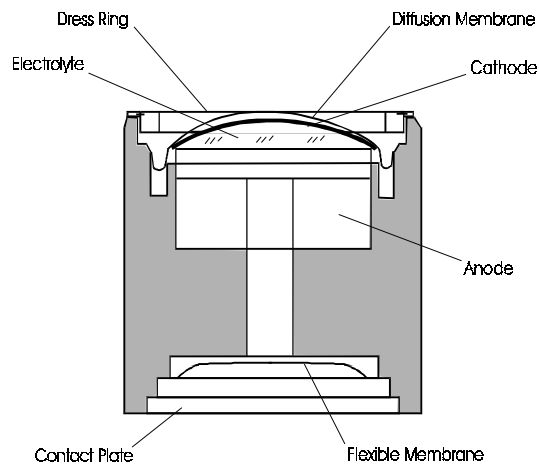

Figure 2-2. Cross Section of a Micro-Fuel Cell (not to scale)

At the top end of the cell is a diffusion membrane of Teflon, whose thickness is very accurately controlled. Beneath the diffusion membrane lies the oxygen sensing element—the cathode—with a surface area almost 4 cm². The cathode has many perforations to ensure sufficient wetting of the upper surface with electrolyte, and it is plated with an inert metal.

The anode structure is below the cathode. It is made of lead and has a proprietary design which is meant to maximize the amount of metal available for chemical reaction.

At the rear of the cell, just below the anode structure, is a flexible membrane designed to accommodate the internal volume changes that occur throughout the life of the cell. This flexibility assures that the sensing membrane remains in its proper position, keeping the electrical output constant.

The entire space between the diffusion membrane, above the cathode, and the flexible rear membrane, beneath the anode, is filled with electrolyte. Cathode and anode are submerged in this common pool. They each have a conductor connecting them to one of the external contact rings on the contact plate, which is on the bottom of the cell.

2.2.3 Electrochemical Reactions

The sample gas diffuses through the Teflon membrane. Any oxygen in the sample gas is reduced on the surface of the cathode by the following HALF REACTION:

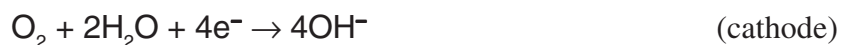

(Four electrons combine with one oxygen molecule—in the presence of water from the electrolyte—to produce four hydroxyl ions.)

When the oxygen is reduced at the cathode, lead is simultaneously oxidized at the anode by the following HALF REACTION:



(Two electrons are transferred for each atom of lead that is oxidized. Therefore it takes two of the above anode reactions to balance one cathode reaction and transfer four electrons.)

The electrons released at the surface of the anode flow to the cathode surface when an external electrical path is provided. The current is proportional to the amount of oxygen reaching the cathode. It is measured and used to determine the oxygen concentration in the gas mixture.

The overall reaction for the fuel cell is the SUM of the half reactions above, or:

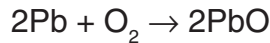

(These reactions will hold as long as no gaseous components capable of oxidizing lead—such as iodine, bromine, chlorine and fluorine—are present in the sample.)

The output of the fuel cell is limited by (1) the amount of oxygen in the cell at the time and (2) the amount of stored anode material.

In the absence of oxygen, no current is generated.

2.2.4 The Effect of Pressure

In order to state the amount of oxygen present in the sample in parts-per-million or a percentage of the gas mixture, it is necessary that the sample diffuse into the cell under constant pressure.

If the total pressure increases, the rate that oxygen reaches the cathode through the diffusing membrane will also increase. The electron transfer, and therefore the external current, will increase, even though the oxygen concentration of the sample has not changed. It is therefore important that the sample pressure at the fuel cell (usually vent pressure) remain relatively constant between calibrations.

2.2.5 Calibration Characteristics

Given that the total pressure of the sample gas on the surface of the Micro-Fuel Cell input is constant, a convenient characteristic of the cell is that the current produced in an external circuit is directly proportional to the rate at which oxygen molecules reach the cathode, and this rate is directly proportional to the concentration of oxygen in the gaseous mixture. In other words it has a linear characteristic curve, as shown in Figure 2-3. Measuring circuits do not have to compensate for nonlinearities.

In addition, since there is almost no output in the absence of oxygen, the characteristic curve has close to an absolute zero—within ± 1 ppm oxygen. (The electronics is zeroed automatically when the instrument power is turned on.)

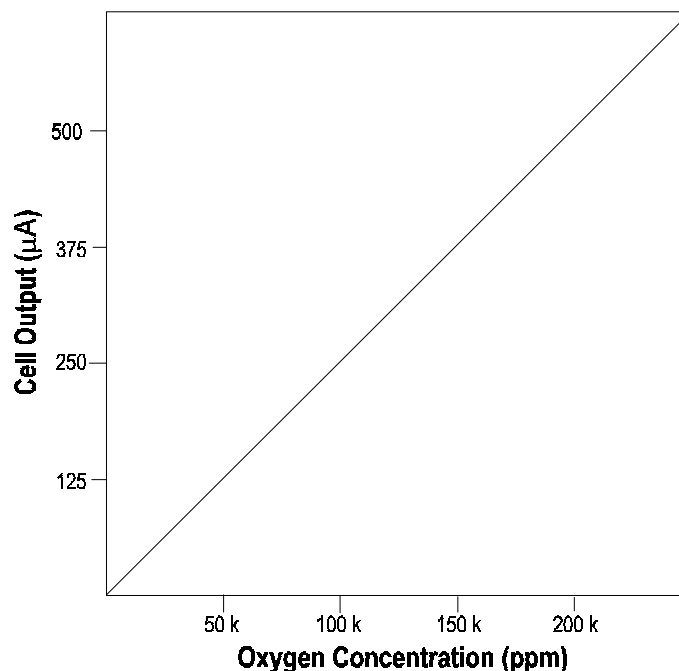

Figure 2-3. Characteristic Input/Output Curve for a Micro-Fuel Cell

2.2.6 Micro-Fuel Cell “Class”

TAI manufactures Micro-Fuel Cells with a variety of characteristics to give the best possible performance for any given sample conditions. A few typical Micro-Fuel Cells are listed below with their typical use and electrical specifications.

2.2.6.1 Class A-3 Cell

The class A-3 cell is for use in applications where it is exposed continuously to carbon dioxide concentrations between 1 % and 100 % in the sample gas.

Nominal output in air is 0.20 mA, and 90 % response time is 45 s. Expected life in flue gas is 8 months.

2.2.6.2 Class A-5 Cell

The class A-5 cell is for use in applications where it is exposed intermittently to carbon dioxide concentrations up to 100 % in the sample gas.

Nominal output in air is 0.19 mA, and 90 % response time is 45 s. Expected life in flue gas is 8 months.

2.2.6.3 Class B-1 Cell

The class B-1 cell is for use in applications where it is exposed to less than 0.1 % of carbon dioxide, and where fast response is important.

Nominal output in air is 0.50 mA, and 90 % response time is 7 s.
Expected life in air is 8 months.

2.2.6.4 Class B-3 Cell

The class B-3 cell is for use in applications where a slightly longer response time is acceptable in order to have a longer cell life.

Nominal output in air is 0.30 mA, and 90 % response time is 13 s.
Expected life in air is 12 months.

2.2.6.5 Class C-3 Cell

The class B-1 cell is for use in applications where it is exposed to less than 0.1 % of carbon dioxide, and where a longer response time is acceptable in order to have a longer cell life.

Nominal output in air is 0.20 mA, and 90 % response time is 30 s.
Expected life in air is 18 months.

2.2.6.6 Hydrogen and/or Helium Service

If the sample gas contains 10 % or more hydrogen and/or helium, “clamp” cells are used. These Micro-Fuel cells are identified by the suffix -C added to the cell class number.

Installation

Installation of the Model 3010PAC Analyzer includes:

1. Unpacking, mounting, and interconnecting the Control Unit and the Analysis Unit
2. Making gas connections to the system
3. Making electrical connections to the system
4. Testing the system.

3.1 Unpacking the Analysis Unit

The analyzer is shipped with all materials needed to install and prepare the system for operation. Carefully unpack the Analysis Unit and inspect it for damage. Immediately report any damage to the shipping agent.

3.2 Mounting the Analysis Unit

The analyzer should be installed in an area that is sheltered from the elements. In areas where the ambient temperature is expected to drop below 0°C, auxiliary heating must be provided.

Install the probe with a suitable sample system in an area that is protected from the elements and from possible RFI. The temperature limits are the same as those specified for the sensor, but you can obtain better accuracy if the temperature is held constant. The sample system must be such as to provide a suitable flowrate of approximately 1000ml/minute at a constant temperature. Also, the sample system should include some means of introducing a span gas.

Three outline diagrams are included among the drawings at the rear of this manual. The diagrams show the location and identification of the electrical conduit connections, as well as the physical dimensions of the separate units that comprise the analyzer.

If you use your own gas control valves, use the interconnect diagram in Figure 3-5 for the valves. The sensor and thermistor remain connected as in Figure 3-4, above.

3.3 Installing the Micro-Fuel Cell

The Micro-Fuel Cell is not installed in the cell block when the instrument is shipped. It must be installed during initial installation.

Once it is expended, the Micro-Fuel Cell will need to be replaced. The cell could also require replacement if the cell is exposed to air for too long, or if the instrument has been idle for too long.

When the micro-Fuel Cell needs to be installed or replaced, follow the procedures in chapter 5, *Maintenance*, for removing and installing cells.

3.4 Testing the System

After The Control Unit and the Analysis Unit are **both** installed and interconnected, and the system gas and electrical connections are complete, the system is ready to test. **Before** plugging either of the units into their respective power sources:

- Check the integrity and accuracy of the gas connections. Make sure there are no leaks.
- Check the integrity and accuracy of the electrical connections. Make sure there are no exposed conductors

Power up the system, and test it as follows:

1. Repeat the Self-Diagnostic Test as described in Part I, chapter 4, section 4.3.5.

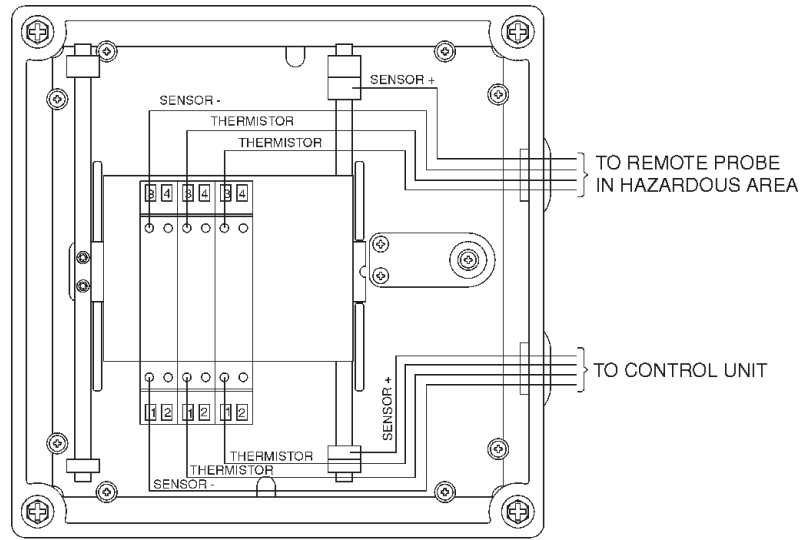

INTRINSIC SAFE ZENER BARRIERS & ENCLOSURE

3.5 Intrinsic Safety Barriers

Two intrinsic safety barrier strips (one each P/N B366 single channel, B367 dual channel) are installed between the cell and the control unit. The barrier strips are housed in an approved bulkhead mountable barrier box (P/N E324). Refer to drawing D66191 for terminal connection.

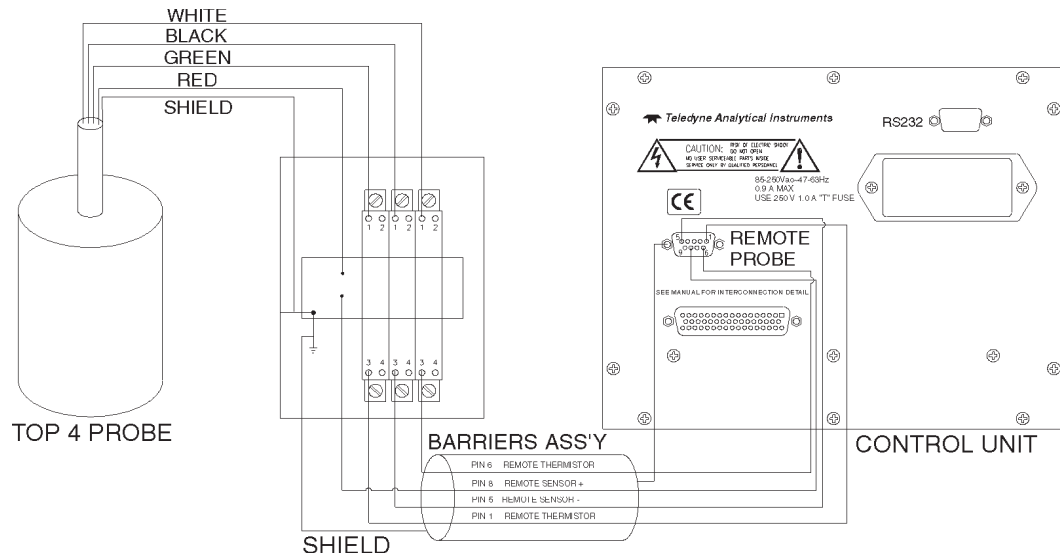
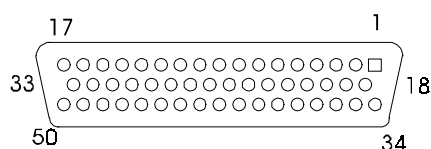

Figure 3-4: Control Unit (CU) to Analysis Unit (AU) Connector Cable

D - SUB CONNECTOR'S DESCRIPTION

| PIN # | Description |
|-------|----------------------|
| 3 | + Range ID 4-20 mA |
| 4 | - Range ID 4-20 mA |
| 5 | + Output 4-20 mA |
| 6 | - Output 4-20 mA |
| 7 | - Output 0-1 V |
| 8 | + Range ID 0-1 V |
| 13 | Network + |
| 15 | Zero Solenoid Return |
| 16 | Span Solenoid Return |
| 17 | Span Solenoid Hot |
| 18 | Range 3 Contact |
| 19 | Range 3 Contact |
| 20 | Alarm 3 C Contact |
| 21 | Range 1 Contact |
| 22 | Range 2 Contact |
| 23 | - Range ID 0-1 V |
| 24 | + Output 0-1 V |
| 28 | Alarm 1 C Contact |
| 29 | Network - |
| 32 | Exhaust Solenoid Hot |
| 33 | Sample Solenoid Hot |
| 34 | Range 4 Contact |
| 35 | Range 4 Contact |
| 36 | Alarm 3 NC Contact |
| 37 | Alarm 3 NO Contact |
| 38 | Range 1 Contact |
| 39 | Range 2 Contact |

| | |
|----|-------------------------|
| 40 | Calibration Contact |
| 41 | Calibration Contact |
| 42 | Alarm 2 NC Contact |
| 43 | Alarm 2 NO Contact |
| 44 | Alarm 2 C Contact |
| 45 | Alarm 1 NC Contact |
| 46 | Alarm 1 NO Contact |
| 48 | Exhaust Solenoid Return |
| 49 | Zero Solenoid |
| 50 | Sample Solenoid Return |



3.5 Remote Probe Connection

The Models 3010PAC are split architecture (dual-chassis) instruments, which have a Remote Probe, or Analysis Unit. The remote probe is for receiving the oxygen sensor and thermistor signals.

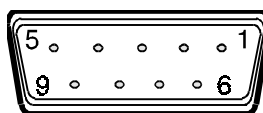

Remote Probe 9-pin Connector

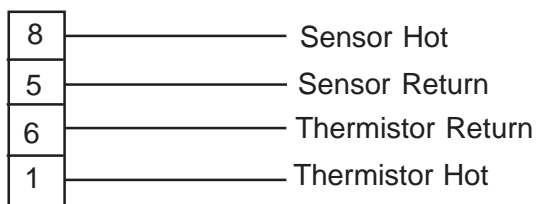

Figure 3-: Remote Probe Interface Pinout

Maintenance

4.1 Routine Maintenance



Aside from normal cleaning and checking for leaks at the gas connections, routine maintenance is limited to replacing Micro-Fuel cells and fuses, and recalibration.



Self-diagnostic testing of the system and fuse replacement in the Control Unit are covered in Part I, chapter 5 of this manual. For recalibration, see Part I, section 4.4 *Calibration*.

WARNING: SEE WARNINGS ON THE TITLE PAGE OF THIS MANUAL.

4.2 When to Replace a Cell

If the 3010P analysis readings begin to drift downward uncharacteristically, try recalibration. If recalibration raises the readings for a short time only, suspect the cell, **but first check for leaks downstream from the cell where gases may be leaking into the system.**

You can check the output of the cell itself by going to the *System* function, selecting *More*, and pressing *Enter*. The cell output reading will be on the second line of the display.

Version Self-Test

Cell Output: ### μ A

The “good” cell output range depends on the class of cell your analyzer is using. The B-1 cell is standard in the 3010PAC, but others can be specified.

Check *Specific Model Information in the Front Matter in this manual for the class of cell you purchased.* Then check Table 5-1, the cell index table below, and do the simple calculation. If the resulting value is below the Cell Output reading, replace the cell.

To find out if your cell is too weak:

1. Flow span gas through the analyzer, and allow time to purge.
2. With span gas flowing, read the raw output of the cell from the *System* function display.
3. Divide the raw output reading by the percent oxygen concentration of your span gas.

If the quotient is less than the Index value for the cell class you are using, replace the cell.

Table 5-1: Cell Indices

| Cell Class | Index |
|------------|-------|
| A-3 | 1.818 |
| A-5 | 1.818 |
| B-1 | 4.545 |
| B-3 | 3.716 |
| B-5 | 1.244 |
| B-7 | 1.515 |
| C-3 | 2.488 |
| C-5 | 0.606 |

4.3 Cell Warranty

The Micro-Fuel cell used in the standard Model 3010PAC is the class B-1 cell. Check *Specific Model Information* in the front matter of this manual for cell class in your unit, as this will affect cell life and warranty data. Also note any Addenda that may be attached to the front of this manual for special information applying to your instrument.

With regard to spare cells, warranty period begins on the date of shipment. The customer should purchase only one spare cell. Do not attempt to stockpile spare cells.

If a cell was working satisfactorily, but ceases to function before the warranty period expires, the customer will receive credit toward the purchase of a new cell.

If you have a warranty claim, you must return the cell in question to the factory for evaluation. If it is determined that failure is due to faulty workmanship or material, the cell will be replaced at no cost to you.

Note: Evidence of damage due to tampering or mishandling will render the cell warranty null and void.

4.4 System Self Diagnostic Test

1. Press the *System* button to enter the system mode.
2. Use the < > arrow keys to move to More, and press *Enter*.
3. Use the < > arrow keys to move to Self-Test, and press *Enter*.
4. Observe the error-code readings on the VFD Display screen, and check Table 5-1, below, to interpret the codes.

Table 5-1: Self Test Failure Codes

Power

| | |
|---|--------------|
| 0 | OK |
| 1 | 5 V Failure |
| 2 | 15 V Failure |
| 3 | Both Failed |

Analog

| | |
|---|-----------------------------|
| 0 | OK |
| 1 | DAC A (0–1 V Concentration) |
| 2 | DAC B (0–1 V Range ID) |
| 3 | Both Failed |

Preamp

| | |
|---|---|
| 0 | OK |
| 1 | Zero too high |
| 2 | Amplifier output doesn't match test input |
| 3 | Both Failed |

OPERATING INSTRUCTIONS

Model 3010PAC

Oxygen Analyzers

Appendix

Flush Mount Control Unit, PN D66192B
CENELEC Type Analysis Unit, PN B39923C

Contents

| | | |
|-----|---|-----|
| A-1 | Model 3010PAC Specifications..... | A-3 |
| A-2 | Recommended 2-Year Spare Parts List | A-5 |
| A-3 | Drawing List | A-6 |
| A-5 | The Zero Functions | A-7 |

Appendix

A-1 Model 3010PAC Specifications

Packaging: General Purpose Control Unit

- Flush panel mount (Standard).
- Rack mount — Relay rack mounted to contain either one or two instruments in one 19" relay rack mountable plate (Optional).

Sensor: B-1 Micro-Fuel Cell (standard); others available.

Cell Block: Nylon (316 stainless steel available).

Ranges: Three user definable ranges 0-1 % to 0-100 %.
Air calibration range 0-25 %.

Autoranging with range ID output.

Sample System: Positive pressure service.
Vacuum service (optional).

Auto Cal / Auto Zero. Electrically operated valves signals available.

Alarms: One system-failure alarm-contact to detect power failure.

Two adjustable concentration threshold alarms with fully programmable setpoints.

Diagnostics: Start-up or on-demand, comprehensive, self testing function initiated by keyboard.

Displays: 2 line by 20 alphanumeric, VFD screen, and one 5 digit LED display. Flowmeter on Analysis Unit.

Digital Interface: Full duplex RS-232 communications port.

Power: General Purpose Control Unit

Universal power supply 85-250 V ac,
47-63 Hz.

Operating Temperature: 0-50 °C

EMF/RFI: Immunity and Emissions designed to meet
(but not yet certified to)

EN 50081-1

EN 50082-2

Accuracy: ±2% of full scale at constant temperature.
±5% of full scale over operating temperature
range, on factory default analysis ranges, once
thermal equilibrium has been achieved.

Analog outputs: 0-1 V dc percent-of-range
0-1 V dc range ID.
4-20 mA dc percent-of-range (optional)
4-20 mA dc range ID (optional)

Password Access: Can be user-configured for password access.

A-2 Recommended 2-Year Spare Parts List

| <i>Qty</i> | <i>Part Number</i> | <i>Description</i> |
|------------|--------------------|--|
| 1 | C67821 | Back Panel Board |
| 1 | C62371 | Front Panel Board |
| 1 | C62368-B | Percent Preamplifier Board |
| 1* | C62365-C | Percent Main Computer Board (standard) |
| 1* | C62365-A | Percent Main Computer Board (4-20 mA) |
| 1 | C65407 | Interface Board |
| 3** | F9 | Fuse, 1 A, 250 V, 3AG, Slow Blow, (US) |
| 3** | F1275 | Fuse, 1 A, 250 V, 5x20 mm, T—Slow Blow, (European) |
| 2 | O38 | O-ring (For percent models only) |
| 1*** | C6689-B1 | Micro-Fuel Cell (For percent models) |
| 1 | A68314 | Backpanel Connector Kit |
| 1 | B366 | Safety Barrier 1 Channel |
| 1 | B367 | Safety Barrier 2 Channel |

* Order one type only: -A, -B, or -C, as appropriate.

** Order one type only: US or European, as appropriate.

*** Check *Specific Model Information* for cell supplied with your unit. See *Cell "Class"* in chapter 2 for descriptions of options. C6689-B1 is used in the standard percent model.

A minimum charge is applicable to spare parts orders.

Note: Orders for replacement parts should include the part number (if available) and the model and serial number of the instrument for which the parts are intended.

Orders should be sent to:

TELEDYNE Analytical Instruments

16830 Chestnut Street
City of Industry, CA 91749-1580

Phone (626) 934-1500, Fax (626) 961-2538
TWX (910) 584-1887 TDYANYL COID

Web: www.teledyne-ai.com

or your local representative.

A-3 Drawing List

D-66192B: Final Assembly/Outline Drawing, Control Unit, 3010PAC

D-66192C: Final Assembly/Outline Drawing, Control Unit, 3010PAC-MA

D66191: Sensor Block Interconnection Diagram

C66426: Safety Barrier Housing Assembly

B39923C: Final Assembly, Top 4 Probe, Percent

NOTE: The MSDS on this material is available upon request through the Teledyne Environmental, Health and Safety Coordinator. Contact at (626) 934-1592

A-5 Zero Cal

The *Zero* button on the front panel is used to enter the zero calibration function. Zero calibration can be performed in either the automatic or manual mode. In the **automatic** mode, an internal algorithm compares consecutive readings from the sensor to determine when the output is within the acceptable range for zero. In the **manual** mode, the operator determines when the reading is within the acceptable range for zero. Make sure the zero gas is connected to the instrument. If you get a CELL FAILURE message skip to section 4.4.1.3.

Auto Mode Zeroing

Press *Zero* to enter the zero function mode. The screen allows you to select whether the zero calibration is to be performed automatically or manually. Use the $\Delta\nabla$ arrow keys to toggle between AUTO and MAN zero settling. Stop when AUTO appears, blinking, on the display.

Zero: Settling: AUTO
<ENT> To Begin

Press *Enter* to begin zeroing.

% Zero
Slope=#### ppm/s

The beginning zero level is shown in the upper left corner of the display. As the zero reading settles, the screen displays and updates information on Slope (unless the Slope starts within the acceptable zero range and does not need to settle further).

Then, and whenever Slope is less than 0.08 for at least 3 minutes, instead of Slope you will see a countdown: 5 Left, 4 Left, and so fourth. These are five steps in the zeroing process that the system must complete, AFTER settling, before it can go back to *Analyze*.

% Zero
4 Left=### ppm/s

The zeroing process will automatically conclude when the output is within the acceptable range for a good zero. Then the analyzer automatically returns to the *Analyze* mode.

Manual Mode Zeroing

Press *Zero* to enter the *Zero* function. The screen that appears allows you to select between automatic or manual zero calibration. Use the $\Delta\nabla$ keys to toggle between AUTO and MAN zero settling. Stop when MAN appears, blinking, on the display.

**Zero: Settling: Man
<ENT> To Begin**

Press *Enter* to begin the zero calibration. After a few seconds the first of five zeroing screens appears. The number in the upper left hand corner is the first-stage zero offset. The microprocessor samples the output at a predetermined rate. It calculates the differences between successive samplings and displays the rate of change as Slope= a value in parts per million per second (ppm/s).

% Zero
Slope=#### ppm/s

NOTE: It takes several seconds for the true Slope value to display. Wait about 10 seconds. Then, wait until Slope is sufficiently close to zero before pressing *Enter* to finish zeroing. Slope is given in ppm/s.

Generally, you have a good zero when Slope is less than 0.05 ppm/s for about 30 seconds. When Slope is close enough to zero, press *Enter*. In a few seconds, the screen will update.

Once span settling completes, the information is stored in the microprocessor, and the instrument automatically returns to *Analyze* mode.

A-4 Material Safety Data Sheet

Section I – Product Identification

Product Name: Micro-Fuel Cells and Super Cells, all classes except A-2C, A-3, and A-5.

Electrochemical Oxygen Sensors, all classes except R-19.

Micro-Fuel Cells, all classes.

Manufacturer: Teledyne Analytical Instruments

Address: 16830 Chestnut Street, City of Industry, CA 91749

Phone: (818) 961-9221

Customer Service: Extension 222

Environmental Health

and Safety: Extension 230

Date Prepared : 04/26/95

Section II – Hazardous Ingredients/Composition

| Material or Component TLV | C.A.S. # | Quantity | OSHA PEL | ACGIH |
|--|-----------|----------|------------------------|------------------------|
| Lead (Pb) | 7439-92-1 | 3–20 gms | 0.05 mg/m ³ | 0.15 mg/m ³ |
| Potassium Hydroxide Solution 15% (KOH) | 1310-58-3 | 1–5 ml | None | 2 mg/m ³ |

Section III – Physical/Chemical Characteristics

| Material Appearance or Component | Boiling Point (°C) | Specific Gravity | Vapor Pressure | Melting Point (°C) | Density | Evap. Rate | Solubility in Water | Odor |
|----------------------------------|--------------------|------------------|----------------|--------------------|---------|------------|---------------------|-----------------------------------|
| Lead | 1744 | 11.34 | na | 328 | na | na | Insoluble | Solid, silver gray, odorless |
| Potassium Hydroxide | 1320 | 2.04 | na | 360 | na | na | Complete | White or slightly yellow, no odor |

Section IV – Fire and Explosion Hazard Data

| | | | | | | | |
|--|--|--------------------------|----|-------------|----|-------------|----|
| Flash Point: | na | Flammable Limits: | na | LEL: | na | UEL: | na |
| Extinguishing Media: | Use extinguishing media appropriate to surrounding fire conditions. No specific agents recommended. | | | | | | |
| Special Fire Fighting Equipment: | Wear NIOSH/OSHA approved self-contained breathing apparatus and protective clothing to prevent contact with skin and eyes. | | | | | | |
| Unusual Fire and Explosion Hazards: | Emits toxic fumes under fire conditions. | | | | | | |

Section V – Reactivity Data

| | |
|---|--|
| Stability: | Stable |
| Incompatibilities: | Aluminum, organic materials, acid chlorides, acid anhydrides, magnesium, copper. Avoid contact with acids and hydrogen peroxide > 52%. |
| Hazardous Decomposition of Byproducts: | Toxic fumes |
| Hazardous Polymerization: | Will not occur. |
| Conditions to Avoid: | |

Section VI – Health Hazard Data

| | |
|-------------------------|--|
| Routes of Entry: | Inhalation: Highly unlikely |
| | Ingestion: May be fatal if swallowed. |
| Skin: | The electrolyte (potassium hydroxide) is corrosive; skin contact may cause irritation or chemical burns. |
| Eyes: | The electrolyte (potassium hydroxide) is corrosive; eye contact may cause irritation or severe chemical burns. |
| Acute Effects: | The electrolyte is harmful if swallowed, inhaled or adsorbed through the skin. It is extremely destructive to tissue of the mucous membranes, stomach, mouth, upper respiratory tract, eyes and skin. |
| Chronic Effects: | Prolonged exposure with the electrolyte has a destructive effect on tissue. |
| | Chronic exposure to lead may cause disease of the blood and blood forming organs, kidneys and liver, damage to the reproductive systems and decrease in fertility in men and women, and damage to the fetus of a pregnant woman. Chronic exposure from the lead contained in this product is extremely unlikely. |

| | |
|---|--|
| Signs and Symptoms of Exposure: | Contact of electrolyte with skin or eyes will cause a burning sensation and/or feel soapy or slippery to touch. Other symptoms of exposure to lead include loss of sleep, loss of appetite, metallic taste and fatigue. |
| Carcinogenicity: | Lead is classified by the IARC as a class 2B carcinogen (possibly carcinogenic to humans) |
| OSHA: | Where airborne lead exposures exceed the OSHA action level, refer to <i>OSHA Lead Standard 1910.1025</i> . |
| NTP: | na |
| Medical Conditions Generally Aggravated by Exposure: | Lead exposure may aggravate disease of the blood and blood forming organs, hypertension, kidneys, nervous and possibly reproductive systems. Those with preexisting skin disorders or eye problems may be more susceptible to the effects of the electrolyte. |
| Emergency First Aid Procedures: | In case of contact with the skin or eyes, immediately flush with plenty of water for at least 15 minutes and remove all contaminated clothing. Get medical attention immediately. If ingested, give large amounts of water and DO NOT INDUCE VOMITING. Obtain medical attention immediately. If inhaled, remove to fresh air and obtain medical attention immediately. |

Section VII – Precautions for Safe Handling and Use

NOTE: The oxygen sensors are sealed, and under normal circumstances, the contents of the sensors do not present a health hazard. The following information is given as a guide in the event that a cell leaks.

| | |
|---|--|
| Protective measures during cell replacement: | Before opening the bag containing the sensor cell, check the sensor cell for leakage. If the sensor cell leaks, do not open the bag. If there is liquid around the cell while in the instrument, wear eye and hand protection. |
| Cleanup Procedures: | Wipe down the area several times with a wet paper towel. Use a fresh towel each time. Contaminated paper towels are considered hazardous waste. |

Section VIII – Control Measures

| | |
|-----------------------------------|-------------------------|
| Eye Protection: | Chemical splash goggles |
| Hand Protection: | Rubber gloves |
| Other Protective Clothing: | Apron, face shield |
| Ventilation: | na |

Section IX – Disposal

Both lead and potassium hydroxide are considered poisonous substances and are regulated under TSCA and SARA Title III.

| | |
|--------------------------|---|
| EPA Waste Number: | D008 |
| California Waste Number: | 181 |
| DOT Information: | RQ Hazardous Waste Solid N.O.S. (Lead) Class 9 NA3077 PG III |
| | Follow all Federal, State and Local regulations. |

Section X – References

Material Safety Data Sheets from J.T. Baker Chemical, Aldrich, Malinckrodt, ASARCO
U.S. Department of Labor form OMB No. 1218-0072
Title 8 California Code of Regulations
TSCA
SARA Title III
CFR 49
CFR 29
CFR 40

NOTE: The above information is believed to be correct and is offered for your information, consideration, and investigation. It should be used as a guide. Teledyne Analytical Instruments shall not be held liable for any damage resulting from handling or from contact with the above product.