

---

OPERATING INSTRUCTIONS FOR

# Model 3000PA-EU

## Percent Oxygen Analyzer



### DANGER



HIGHLY TOXIC AND OR FLAMMABLE LIQUIDS OR GASES MAY BE PRESENT IN THIS MONITORING SYSTEM.

PERSONAL PROTECTIVE EQUIPMENT MAY BE REQUIRED WHEN SERVICING THIS SYSTEM.

HAZARDOUS VOLTAGES EXIST ON CERTAIN COMPONENTS INTERNALLY WHICH MAY PERSIST FOR A TIME EVEN AFTER THE POWER IS TURNED OFF AND DISCONNECTED.

ONLY AUTHORIZED PERSONNEL SHOULD CONDUCT MAINTENANCE AND/OR SERVICING. BEFORE CONDUCTING ANY MAINTENANCE OR SERVICING CONSULT WITH AUTHORIZED SUPERVISOR/MANAGER.

P/N M66317  
12/22/00  
ECO#00-0542

## Copyright © 1999 Teledyne Analytical Instruments

All Rights Reserved. No part of this manual may be reproduced, transmitted, transcribed, stored in a retrieval system, or translated into any other language or computer language in whole or in part, in any form or by any means, whether it be electronic, mechanical, magnetic, optical, manual, or otherwise, without the prior written consent of Teledyne Analytical Instruments, 16830 Chestnut Street, City of Industry, CA 91749-1580.

### Warranty

This equipment is sold subject to the mutual agreement that it is warranted by us free from defects of material and of construction, and that our liability shall be limited to replacing or repairing at our factory (without charge, except for transportation), or at customer plant at our option, any material or construction in which defects become apparent within one year from the date of shipment, except in cases where quotations or acknowledgments provide for a shorter period. Components manufactured by others bear the warranty of their manufacturer. This warranty does not cover defects caused by wear, accident, misuse, neglect or repairs other than those performed by Teledyne or an authorized service center. We assume no liability for direct or indirect damages of any kind and the purchaser by the acceptance of the equipment will assume all liability for any damage which may result from its use or misuse.

We reserve the right to employ any suitable material in the manufacture of our apparatus, and to make any alterations in the dimensions, shape or weight of any parts, in so far as such alterations do not adversely affect our warranty.

### Important Notice

This instrument provides measurement readings to its user, and serves as a tool by which valuable data can be gathered. The information provided by the instrument may assist the user in eliminating potential hazards caused by his process; however, it is essential that all personnel involved in the use of the instrument or its interface, with the process being measured, be properly trained in the process itself, as well as all instrumentation related to it.

The safety of personnel is ultimately the responsibility of those who control process conditions. While this instrument may be able to provide early warning of imminent danger, it has no control over process conditions, and it can be misused. In particular, any alarm or control systems installed must be tested and understood, both as to how they operate and as to how they can be defeated. Any safeguards required such as locks, labels, or redundancy, must be provided by the user or specifically requested of Teledyne at the time the order is placed.

Therefore, the purchaser must be aware of the hazardous process conditions. The purchaser is responsible for the training of personnel, for providing hazard warning methods and instrumentation per the appropriate standards, and for ensuring that hazard warning devices and instrumentation are maintained and operated properly.

Teledyne Analytical Instruments, the manufacturer of this instrument, cannot accept responsibility for conditions beyond its knowledge and control. No statement expressed or implied by this document or any information disseminated by the manufacturer or its agents, is to be construed as a warranty of adequate safety control under the user's process conditions.

## Specific Model Information

The instrument for which this manual was supplied may incorporate one or more options not included with the standard instrument. Commonly available options are listed below, with check boxes. Any that are incorporated in the instrument for which this manual is supplied are indicated by a check mark in the box.

**Instrument Serial Number** \_\_\_\_\_

### includes the following options:

- 3000PA-C:** In addition to all standard features, this model also has separate ports for zero and span gases, and built-in control valves. The internal valves are entirely under the control of the 3000PA electronics, to automatically switch between gases in synchronization with the analyzer's operations
  
- 3000PA-S:** In models with this option, all wetted parts are made from 316 stainless steel.
  
- 3000PA-M:** In models with this option, the 4-20 mA Analog Current output is active. (In the standard units, it is not active.)
  
- 19" Rack Mnt:** The 19" Relay Rack Mount units are available with either one or two 3000 series analyzers installed on a 19" panel, and ready to mount in a standard rack.
  
- Cell Class:** \_\_\_\_\_ See *Maintenance* for Specs.  
Enter Class Designation.

## Model 3000PA

---

Model 3000PA-EU complies with all of the requirements of the Commonwealth of Europe (CE) for Radio Frequency Interference, Electromagnetic Interference (RFI/EMI), and Low Voltage Directive (LVD).

The following International Symbols are used throughout the Instruction Manual for your visual and immediate warnings and when you have to attend CAUTION while operating the instrument:



**STAND-BY**, Instrument is on Stand-by, but circuit is active



**GROUND**  
Protective Earth



**CAUTION**, The operator needs to refer to the manual for further information. Failure to do so may compromise the safe operation of the equipment.



**CAUTION**, Risk of Electric Shock



This is a general purpose instrument designed for usage in a nonhazardous area. It is the customer's responsibility to ensure safety especially when combustible gases are being analyzed since the potential of gas leaks always exist.

The customer should ensure that the principles of operating of this equipment is well understood by the user. Misuse of this product in any manner, tampering with its components, or unauthorized substitution of any component may adversely affect the safety of this instrument.

Since the use of this instrument is beyond the control of Teledyne, no responsibility by Teledyne, its affiliates, and agents for damage or injury from misuse or neglect of this equipment is implied or assumed.

## Table of Contents

|          |   |      |
|----------|---|------|
| <b>1</b> | <b>Introduction</b>                             |      |
| 1.1      | Overview .....                                  | 1-1  |
| 1.2      | Typical Applications .....                      | 1-1  |
| 1.3      | Main Features of the Analyzer .....             | 1-1  |
| 1.4      | Model Designations .....                        | 1-2  |
| 1.5      | Front Panel (Operator Interface) .....          | 1-3  |
| 1.6      | Rear Panel (Equipment Interface) .....          | 1-5  |
| <b>2</b> | <b>Operational Theory</b>                       |      |
| 2.1      | Introduction .....                              | 2-1  |
| 2.2      | Micro-Fuel Cell Sensor .....                    | 2-1  |
| 2.2.1    | Principles of Operation .....                   | 2-1  |
| 2.2.2    | Anatomy of a Micro-Fuel Cell .....              | 2-2  |
| 2.2.3    | Electrochemical Reactions .....                 | 2-3  |
| 2.2.4    | The Effect of Pressure .....                    | 2-4  |
| 2.2.5    | Calibration Characteristics .....               | 2-4  |
| 2.2.6    | Micro-Fuel Cell “Class” .....                   | 2-5  |
| 2.3      | Sample System .....                             | 2-6  |
| 2.4      | Electronics and Signal Processing .....         | 2-8  |
| <b>3</b> | <b>Installation</b>                             |      |
| 3.1      | Unpacking the Analyzer .....                    | 3-1  |
| 3.2      | Mounting the Analyzer .....                     | 3-1  |
| 3.3      | Rear Panel Connections .....                    | 3-2  |
| 3.3.1    | Gas Connections .....                           | 3-3  |
| 3.3.2    | Electrical Connections .....                    | 3-4  |
| 3.3.2.1  | Primary Input Power .....                       | 3-4  |
| 3.3.2.2  | 50-Pin Equipment Interface Connector .....      | 3-5  |
| 3.3.2.3  | RS-232 Port .....                               | 3-9  |
| 3.4      | Installing the Micro-Fuel Cell .....            | 3-10 |
| 3.5      | Testing the System .....                        | 3-12 |
| <b>4</b> | <b>Operation</b>                                |      |
| 4.1      | Introduction .....                              | 4-1  |
| 4.2      | Using the Data Entry and Function Buttons ..... | 4-2  |
| 4.3      | The <i>System</i> Function .....                | 4-3  |
| 4.3.1    | Setting the Display .....                       | 4-4  |
| 4.3.2    | Setting up an Auto-Cal .....                    | 4-5  |
| 4.3.3    | Password Protection .....                       | 4-5  |
| 4.3.3.1  | Entering the Password .....                     | 4-6  |

# Model 3000PA

---

|         |   |      |
|---------|---|------|
| 4.3.3.2 | Installing or Changing the Password ..... | 4-7  |
| 4.3.4   | Logout .....                              | 4-8  |
| 4.3.5   | System Self-Diagnostic Test .....         | 4-9  |
| 4.3.6   | Version Screen .....                      | 4-9  |
| 4.4     | The <i>Zero Span</i> Functions .....      | 4-10 |
| 4.4.1   | Cell Failure .....                        | 4-10 |
| 4.4.2   | Span Cal .....                            | 4-11 |
| 4.4.2.1 | Auto Mode Spanning .....                  | 4-11 |
| 4.4.2.2 | Manual Mode Spanning .....                | 4-12 |
| 4.5     | The <i>Alarms</i> Function .....          | 4-12 |
| 4.6     | The <i>Range</i> Function .....           | 4-15 |
| 4.6.1   | Setting the Analog Output Ranges .....    | 4-15 |
| 4.6.2   | Autoranging Analysis .....                | 4-16 |
| 4.6.3   | Fixed Range Analysis .....                | 4-16 |
| 4.7     | The <i>Analyze</i> Function .....         | 4-17 |
| 4.8     | Signal Output .....                       | 4-17 |

## Maintenance

|       |  |     |
|-------|--|-----|
| 5.1   | Routine Maintenance .....                    | 5-1 |
| 5.2   | Cell Replacement .....                       | 5-1 |
| 5.2.1 | Storing and Handling Replacement Cells ..... | 5-1 |
| 5.2.2 | When to Replace a Cell .....                 | 5-2 |
| 5.2.3 | Removing the Micro-Fuel Cell .....           | 5-3 |
| 5.2.4 | Installing a New Micro-Fuel Cell .....       | 5-5 |
| 5.2.5 | Cell Warranty .....                          | 5-5 |
| 5.3   | Fuse Replacement .....                       | 5-6 |
| 5.4   | System Self Diagnostic Test .....            | 5-6 |
| 5.5   | Major Internal Components .....              | 5-7 |
| 5.6   | Cleaning .....                               | 5-8 |
| 5.7   | Troubleshooting .....                        | 5-9 |

## Appendix

|     |  |     |
|-----|--|-----|
| A-1 | Model 3000PA Specifications .....                        | A-1 |
| A-2 | Recommended 2-Year Spare Parts List .....                | A-3 |
| A-3 | Drawing List .....                                       | A-4 |
| A-4 | 19-Inch Relay Rack Panel Mount .....                     | A-4 |
| A-5 | Application Notes on Restrictors, Pressures & Flow ..... | A-5 |
| A-5 | Zero Functions .....                                     | A-8 |

## **Introduction**

---

### **1.1 Overview**

The Teledyne Analytical Instruments Model 3000PA Percent Oxygen Analyzer is a versatile microprocessor-based instrument for detecting the percentage of oxygen in a variety of background gases. This manual covers only the Model 3000PA General Purpose flush-panel and/or rack-mount units with CE mark. These units are for indoor use in a nonhazardous environment.

### **1.2 Typical Applications**

A few typical applications of the Model 3000PA are:

- Monitoring inert gas blanketing
- Air separation and liquefaction
- Chemical reaction monitoring
- Semiconductor manufacturing
- Petrochemical process control
- Quality assurance
- Gas analysis certification.

### **1.3 Main Features of the Analyzer**

The Model 3000PA Percent Oxygen Analyzer is sophisticated yet simple to use. The main features of the analyzer include:

- A 2-line alphanumeric display screen, driven by microprocessor electronics, that continuously prompts and informs the operator.
- High resolution, accurate readings of oxygen content from low percent levels through 100 %. Large, bright, meter readout.

- Advanced Micro-Fuel Cell, designed for percent oxygen analysis. Several options are available.
- Versatile analysis over a wide range of applications.
- Microprocessor based electronics: 8-bit CMOS microprocessor with 32 kB RAM and 128 kB ROM.
- Three user definable output ranges (from 0-1% through 0-100 %) allow best match to users process and equipment.
- Air-calibration range for convenient spanning at 20.9 %.
- Auto Ranging allows analyzer to automatically select the proper preset range for a given measurement. Manual override allows the user to lock onto a specific range of interest.
- Two adjustable concentration alarms and a system failure alarm.
- Extensive self-diagnostic testing, at startup and on demand, with continuous power-supply monitoring.
- CE Compliance.
- RS-232 serial digital port for use with a computer or other digital communication device.
- Analog outputs for percent-of-range and for range identification. 0–1 V dc. (Isolated 4–20 mA dc optional)
- Convenient and versatile, steel, flush-panel or rack-mountable case with slide-out electronics drawer.

## **1.4 Model Designations**

**3000PA:** Standard model.

**3000PA-C:** In addition to all standard features, this model also has separate ports for zero and span gases, and built-in control valves. The internal valves are entirely under the control of the 3000PA electronics, to automatically switch between gases in synchronization with the analyzer's operations.

**3000PA-M:** This model has current output signals (4-20 mA) for percent-of-range and range ID, in addition to voltage outputs.

**3000PA-S:** A Stainless Steel Probe and Probe Holder are used in this model, for use where resistance to corrosion is important.

**3000PA-V:** Gas flow through the cell block in this model is driven by vacuum downstream from the cell block, instead of by pressure upstream. The internal restrictor is located downstream from the cell block to support this configuration. All other standard features are present in this model.

All of the above options are available in combination. For example, the -C and -V options are combined as Model 3000PA-C-V.

## 1.5 Front Panel (Operator Interface)

The standard 3000PA is housed in a rugged metal case with all controls and displays accessible from the front panel. See Figure 1-1. The front panel has thirteen buttons for operating the analyzer, a digital meter, an alphanumeric display, and a window for viewing the sample flowmeter.

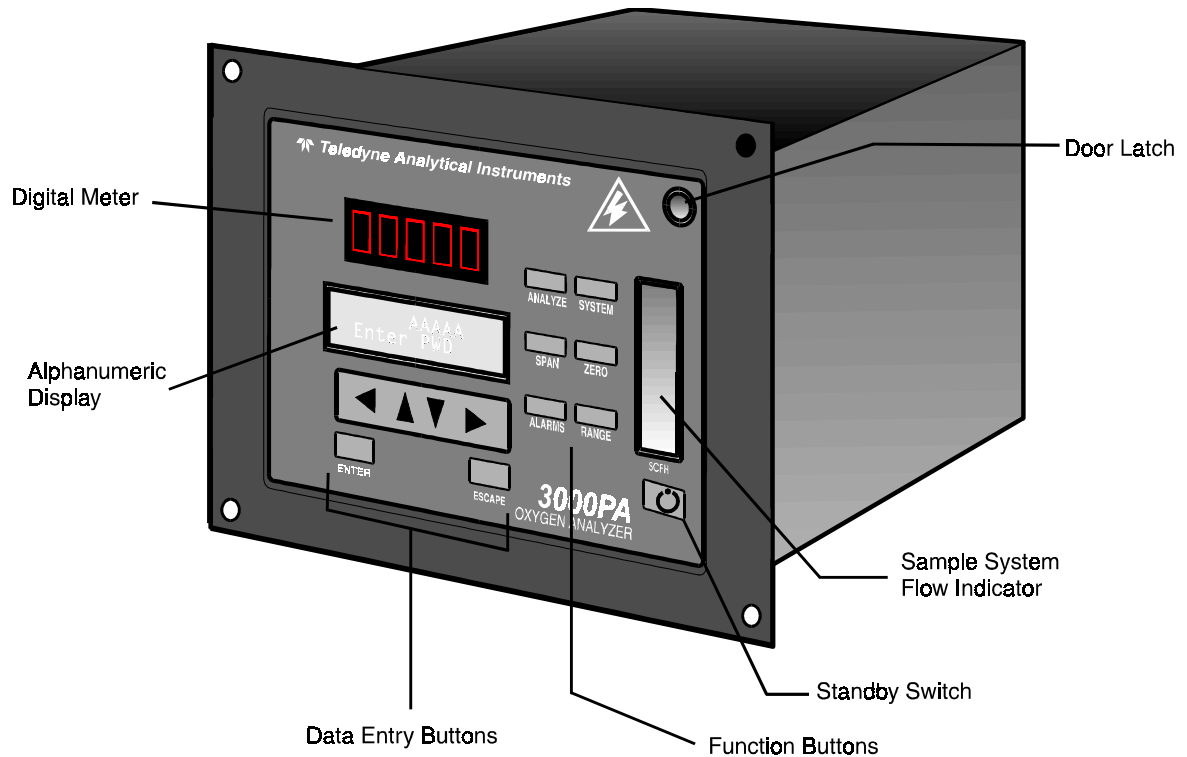

Figure 1-1: Model 3000PA Front Panel

**Function Keys:** Six touch-sensitive membrane switches are used to change the specific function performed by the analyzer:

- **Analyze** Perform analysis for oxygen content of a sample gas.

- **System** Perform system-related tasks (described in detail in chapter 4, *Operation*).
- **Span** Span calibrate the analyzer.
- **Zero** Zero calibrate the analyzer.
- **Alarms** Set the alarm setpoints and attributes.
- **Range** Set up the 3 user definable ranges for the instrument.

**Data Entry Keys:** Six touch-sensitive membrane switches are used to input data to the instrument via the alphanumeric VFD display:

- **Left & Right Arrows** Select between functions currently displayed on the VFD screen.
- **Up & Down Arrows** Increment or decrement values of functions currently displayed.
- **Enter** Moves VFD display on to the next screen in a series. If none remains, returns to the *Analyze* screen.
- **Escape** Moves VFD display back to the previous screen in a series. If none remains, returns to the *Analyze* screen.

**Digital Meter Display:** The meter display is a LED device that produces large, bright, 7-segment numbers that are legible in any lighting environment. It produces a continuous readout from 0-100 %. It is accurate across all ranges without the discontinuity of analog range switching.

**Alphanumeric Interface Screen:** The VFD screen is an easy-to-use interface from operator to analyzer. It displays values, options, and messages that give the operator immediate feedback.

**Flowmeter:** Monitors the flow of gas past the sensor. Readout is 0.2 to 2.4 standard liters per minute (SLPM).

 **Standby Button:** The *Standby* turns off the display and outputs, but circuitry is still operating.

**CAUTION:** *The power cable must be unplugged to fully disconnect power from the instrument. When chassis is exposed or when access door is open and power cable is connected, use extra care to avoid contact with live electrical circuits.*



**Access Door:** To provide access to the Micro-Fuel Cell and the front panel electronics, the front panel swings open when the latch in the upper right corner of the panel is pressed all the way in with a narrow gauge tool.

Accessing the other circuit board requires unfastening the rear panel screws and sliding the electronics drawer out of the case.

## 1.6 Recognizing Difference Between LCD & VFD

LCD has *GREEN* background with *BLACK* characters. VFD has *DARK* background with *GREEN* characters. In the case of VFD - *NO CONTRAST ADJUSTMENT IS NEEDED*.

## 1.7 Rear Panel (Equipment Interface)

The rear panel, shown in Figure 1-2, contains the gas and electrical connectors for external inlets and outlets. The Zero and Span gas connectors, and the Current signal outputs are optional and may not appear on your instrument. The connectors are described briefly here and in detail in the *Installation* chapter of this manual.

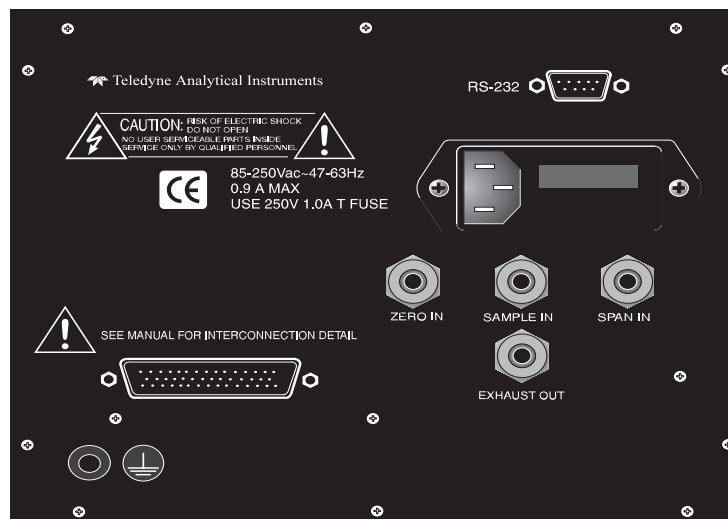

Figure 1-2: Model 3000PA Rear Panel



- **Power Connection** Universal AC power source.
- **Gas Inlet and Outlet** One inlet (must be externally valved) and one exhaust out. Three inlets when “C” option is ordered.
- **9-Pin RS-232 Port** Serial digital concentration signal output and control input.
- **50-Pin Equipment Interface Port**

- **Analog Outputs** 0-1 V dc concentration output, plus 0-1 V dc range ID.
- **Alarm Connections** 2 concentration alarms and 1 system alarm.
- **Remote Valve** Used in the 3000PA for controlling external solenoid valves only.
- **Remote Span/Zero** Digital inputs allow external control of analyzer calibration. (See Note, below.)
- **Calibration Contact** To notify external equipment that instrument is being calibrated and readings are not monitoring sample.
- **Range ID Contacts** Four separate, dedicated, range relay contacts. Low, Medium, High, Cal.
- **Network** For future expansion. Not implemented at this printing.

**Optional:**

- **Calibration Gas Ports** Separate fittings for zero, span and sample gas input, and internal valves for automatically switching the gases.
- **Current Signal Output** Additional isolated 4-20 mA dc plus 4-20 mA dc range ID.

**Note:** If you require highly accurate Auto-Cal timing, use external Auto-Cal control where possible. The internal clock in the Model 3000PA is accurate to 2-3 %. Accordingly, internally scheduled calibrations can vary 2-3 % per day.

## Operational Theory

---

### 2.1 Introduction

The analyzer is composed of three subsystems:

1. Micro-Fuel Cell Sensor
2. Sample System
3. Electronic Signal Processing, Display and Control

The sample system is designed to accept the sample gas and transport it through the analyzer without contaminating or altering the sample prior to analysis. The Micro-Fuel Cell is an electrochemical galvanic device that translates the amount of oxygen present in the sample into an electrical current. The electronic signal processing, display and control subsystem simplifies operation of the analyzer and accurately processes the sampled data. The microprocessor controls all signal processing, input/output and display functions for the analyzer.

### 2.2 Micro-Fuel Cell Sensor

#### 2.2.1 Principles of Operation

The oxygen sensor used in the Model 3000P series is a Micro-Fuel Cell designed and manufactured by Analytical Instruments. It is a sealed plastic disposable electrochemical transducer.

The active components of the Micro-Fuel Cell are a cathode, an anode, and the 15% aqueous KOH electrolyte in which they are immersed. The cell converts the energy from a chemical reaction into an electrical current in an external electrical circuit. Its action is similar to that of a battery.

There is, however, an important difference in the operation of a battery as compared to the Micro-Fuel Cell: In the battery, all reactants are stored within the cell, whereas in the Micro-Fuel Cell, one of the reactants (oxygen) comes from outside the device as a constituent of the sample gas being

analyzed. The Micro-Fuel Cell is therefore a hybrid between a battery and a true fuel cell. (All of the reactants are stored externally in a true fuel cell.)

**2.2.2 Anatomy of a Micro-Fuel Cell**

The Micro-Fuel Cell is a cylinder only 1¼ inches in diameter and 1 inch thick. It is made of extremely inert plastic, which can be placed confidently in practically any environment or sample stream. It is effectively sealed, although one end is permeable to oxygen in the sample gas. The other end of the cell is a contact plate consisting of two concentric foil rings. The rings mate with spring-loaded contacts in the sensor block assembly and provide the electrical connection to the rest of the analyzer. Figure 2-1 illustrates the external features.

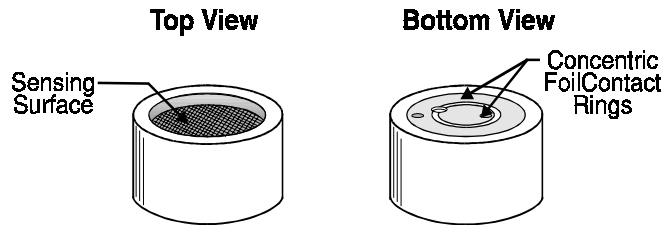

Figure 2-1: Micro-Fuel Cell

Refer to Figure 2-2, *Cross Section of a Micro-Fuel Cell*, which illustrates the following internal description.

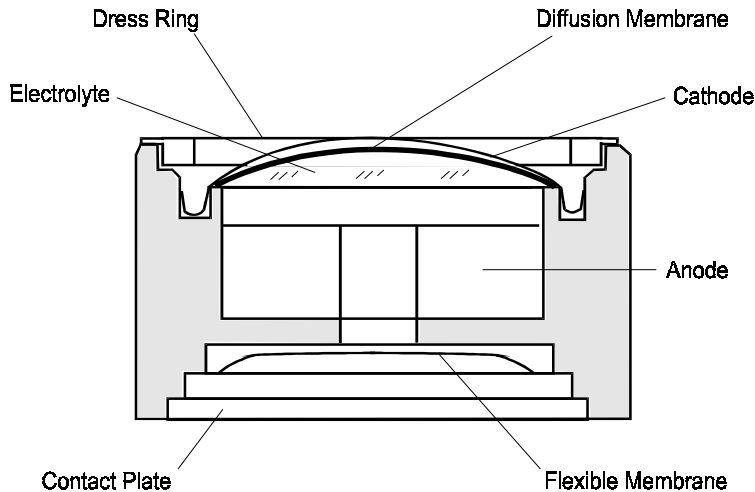

Figure 2-2. *Cross Section of a Micro-Fuel Cell (not to scale)*

At the top end of the cell is a diffusion membrane of Teflon, whose thickness is very accurately controlled. Beneath the diffusion membrane lies

the oxygen sensing element—the cathode—with a surface area almost 4 cm<sup>2</sup>. The cathode has many perforations to ensure sufficient wetting of the upper surface with electrolyte, and it is plated with an inert metal.

The anode structure is below the cathode. It is made of lead and has a proprietary design which is meant to maximize the amount of metal available for chemical reaction.

At the rear of the cell, just below the anode structure, is a flexible membrane designed to accommodate the internal volume changes that occur throughout the life of the cell. This flexibility assures that the sensing membrane remains in its proper position, keeping the electrical output constant.

The entire space between the diffusion membrane, above the cathode, and the flexible rear membrane, beneath the anode, is filled with electrolyte. Cathode and anode are submerged in this common pool. They each have a conductor connecting them to one of the external contact rings on the contact plate, which is on the bottom of the cell.

### 2.2.3 Electrochemical Reactions

The sample gas diffuses through the Teflon membrane. Any oxygen in the sample gas is reduced on the surface of the cathode by the following HALF REACTION:



(Four electrons combine with one oxygen molecule—in the presence of water from the electrolyte—to produce four hydroxyl ions.)

When the oxygen is reduced at the cathode, lead is simultaneously oxidized at the anode by the following HALF REACTION:

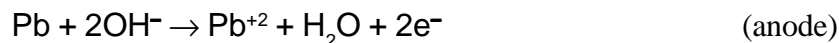

(Two electrons are transferred for each atom of lead that is oxidized. Therefore it takes two of the above anode reactions to balance one cathode reaction and transfer four electrons.)

The electrons released at the surface of the anode flow to the cathode surface when an external electrical path is provided. The current is proportional to the amount of oxygen reaching the cathode. It is measured and used to determine the oxygen concentration in the gas mixture.

The overall reaction for the fuel cell is the SUM of the half reactions above, or:

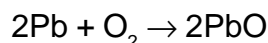

(These reactions will hold as long as no gaseous components capable of oxidizing lead—such as iodine, bromine, chlorine and fluorine—are present in the sample.)

The output of the fuel cell is limited by (1) the amount of oxygen in the cell at the time and (2) the amount of stored anode material.

In the absence of oxygen, no current is generated.

### **2.2.4 The Effect of Pressure**

In order to state the amount of oxygen present in the sample as a percentage of the gas mixture, it is necessary that the sample diffuse into the cell under constant pressure.

If the total pressure increases, the rate that oxygen reaches the cathode through the diffusing membrane will also increase. The electron transfer, and therefore the external current, will increase, even though the oxygen concentration of the sample has not changed. It is therefore important that the sample pressure at the fuel cell (usually vent pressure) remain constant between calibrations.

### **2.2.5 Calibration Characteristics**

Given that the total pressure of the sample gas at the surface of the Micro-Fuel Cell input is constant, a convenient characteristic of the cell is that the current produced in an external circuit is directly proportional to the rate at which oxygen molecules reach the cathode, and this rate is directly proportional to the concentration of oxygen in the gaseous mixture. In other words it has a linear characteristic curve, as shown in Figure 2-3. Measuring circuits do not have to compensate for nonlinearities.

In addition, since there is zero output in the absence oxygen, the characteristic curve has close to an absolute zero. In the percent ranges, the cell itself does not need to be zeroed. In practical application zeroing is still used to compensate for zero offsets in the electronics. (The electronics is zeroed automatically when the instrument power is turned on.)

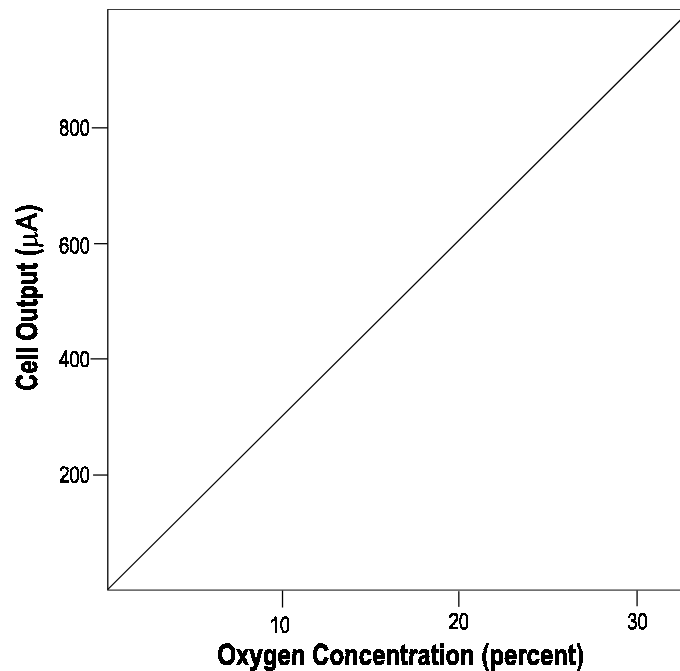

Figure 2-3. Characteristic Input/Output Curve for a Micro-Fuel Cell

### 2.2.6 Micro-Fuel Cell “Class”

TBE manufactures Micro-Fuel Cells with a variety of characteristics to give the best possible performance for any given sample conditions. A few typical Micro-Fuel Cells are listed below with their typical use and electrical specifications.

#### 2.2.6.1 Class A-3 Cell

The class A-3 cell is for use in applications where it is exposed continuously to carbon dioxide concentrations between 1 % and 100 % in the sample gas.

Nominal output in air is 0.20 mA, and 90 % response time is 45 s. Expected life in flue gas is 8 months.

#### 2.2.6.2 Class A-5 Cell

The class A-5 cell is for use in applications where it is exposed intermittently to carbon dioxide concentrations up to 100 % in the sample gas.

Nominal output in air is 0.19 mA, and 90 % response time is 45 s.  
Expected life in flue gas is 8 months.

#### **2.2.6.3 Class B-1 Cell**

The class B-1 cell is for use in applications where it is exposed to less than 0.1 % of carbon dioxide, and where fast response is important.

Nominal output in air is 0.50 mA, and 90 % response time is 7 s.  
Expected life in air is 8 months.

#### **2.2.6.4 Class B-3 Cell**

The class B-3 cell is for use in applications where a slightly longer response time is acceptable in order to have a longer cell life.

Nominal output in air is 0.30 mA, and 90 % response time is 13 s.  
Expected life in air is 12 months.

#### **2.2.6.5 Class C-3 Cell**

The class B-1 cell is for use in applications where it is exposed to less than 0.1 % of carbon dioxide, and where a longer response time is acceptable in order to have a longer cell life.

Nominal output in air is 0.20 mA, and 90 % response time is 30 s.  
Expected life in air is 18 months.

#### **2.2.6.6 Hydrogen and/or Helium Service**

If the sample gas contains 10 % or more hydrogen and/or helium, “clamp” cells are used. These Micro-Fuel cells are identified by the suffix -C added to the cell class number.

### **2.3 Sample System**

The sample system delivers gases to the Micro-Fuel Cell sensor from the analyzer rear panel inlet. Depending on the mode of operation either sample or calibration gas is delivered.

The Model 3000P sample system is designed and fabricated to ensure that the oxygen concentration of the gas is not altered as it travels through the sample system. The sample encounters almost no dead space. This mini-

mizes residual gas pockets that can interfere with very low level oxygen analysis.

The sample system for the standard instrument incorporates 1/4 inch tube fittings for sample inlet and outlet connections at the rear panel. For metric system installations, 6 mm adapters are supplied with each instrument. The sample or calibration gas flow through the system is monitored by a flowmeter downstream from the cell. Figure 2-4 shows the piping layout for the standard model.

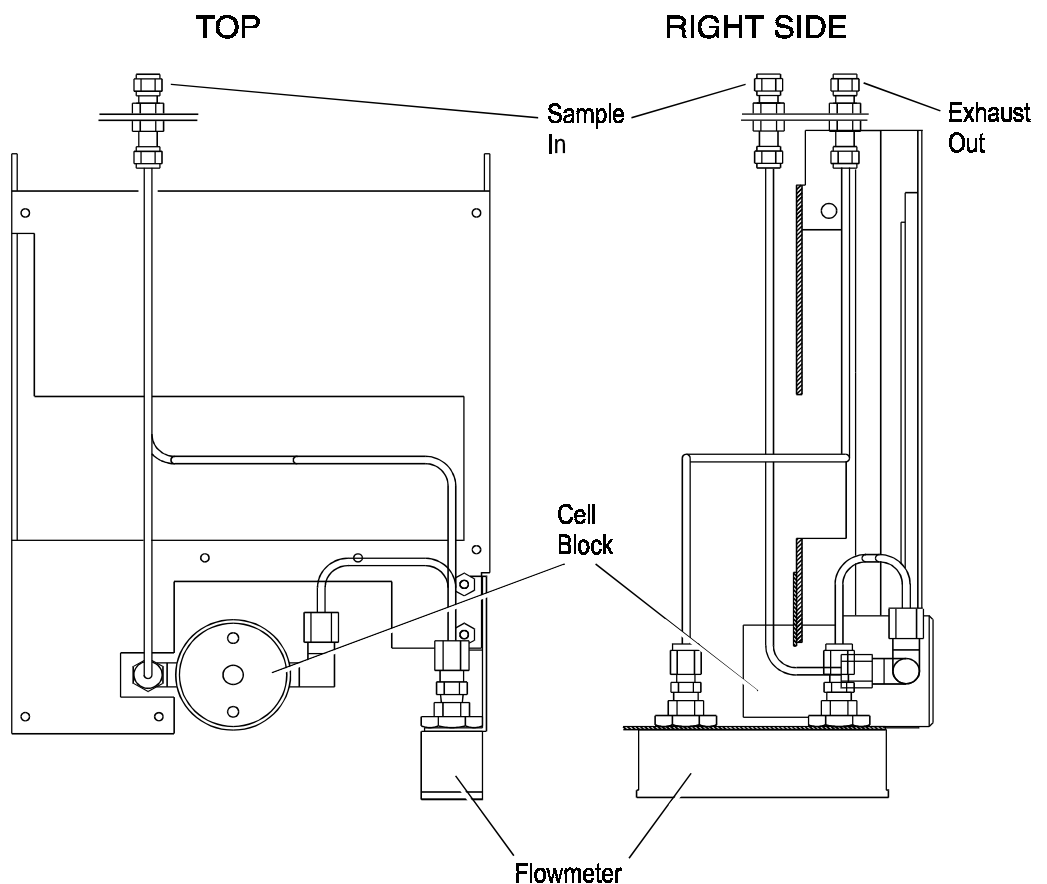

Figure 2-4: Piping Layout and Flow Diagram for Standard Model

Figure 2-5 is the flow diagram for the sampling system. In the standard instrument, calibration gases (zero and span) can be connected directly to the Sample In port by teeing to the port with appropriate valves. The shaded portion of the diagram shows the components added when the -C option is ordered. The valving is installed inside the 3000PA-C enclosure and is regulated by the instrument's internal electronics.

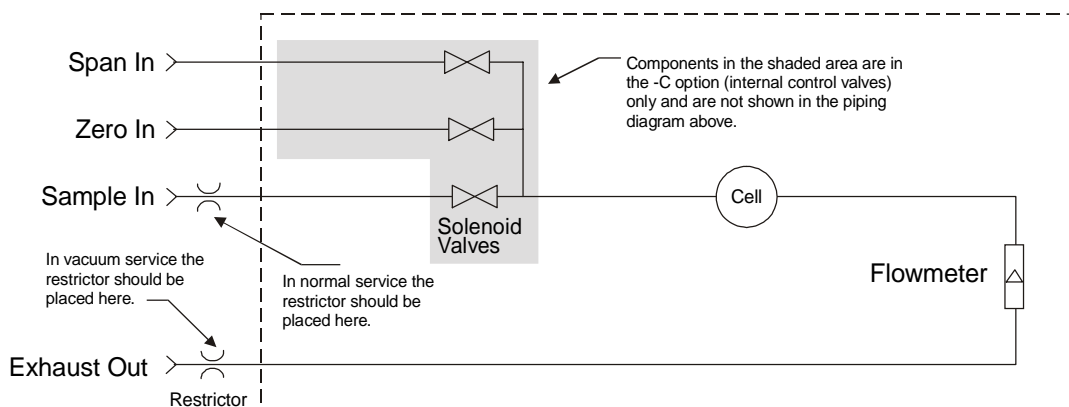

Figure 2-5: Flow Diagram

### 2.4 Electronics and Signal Processing

The Model 3000P Percent Oxygen Analyzer uses an 8031 microcontroller with 32 kB of RAM and 128 kB of ROM to control all signal processing, input/output, and display functions for the analyzer. System power is supplied from a universal power supply module designed to be compatible with any international power source. Figure 2-6 shows the location of the power supply and the main electronic PC boards.

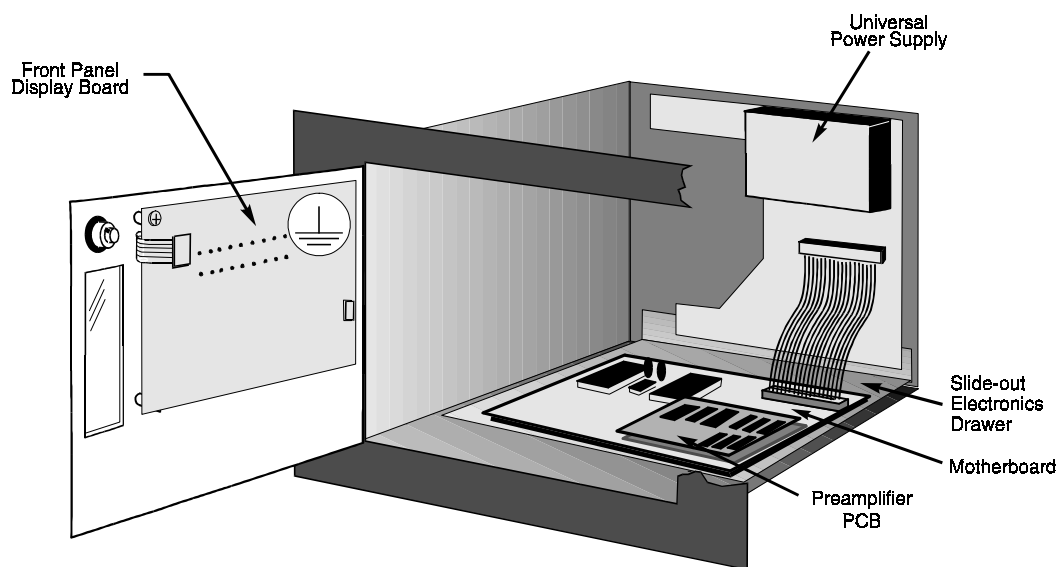

Figure 2-6: Location of Electronic Components

The signal processing electronics including the microprocessor, analog to digital, and digital to analog converters are located on the motherboard at the bottom of the case. The preamplifier board is mounted on top of the motherboard as shown in the figure. These boards are accessible after removing the back panel. Figure 2-7 is a block diagram of the Analyzer electronics.

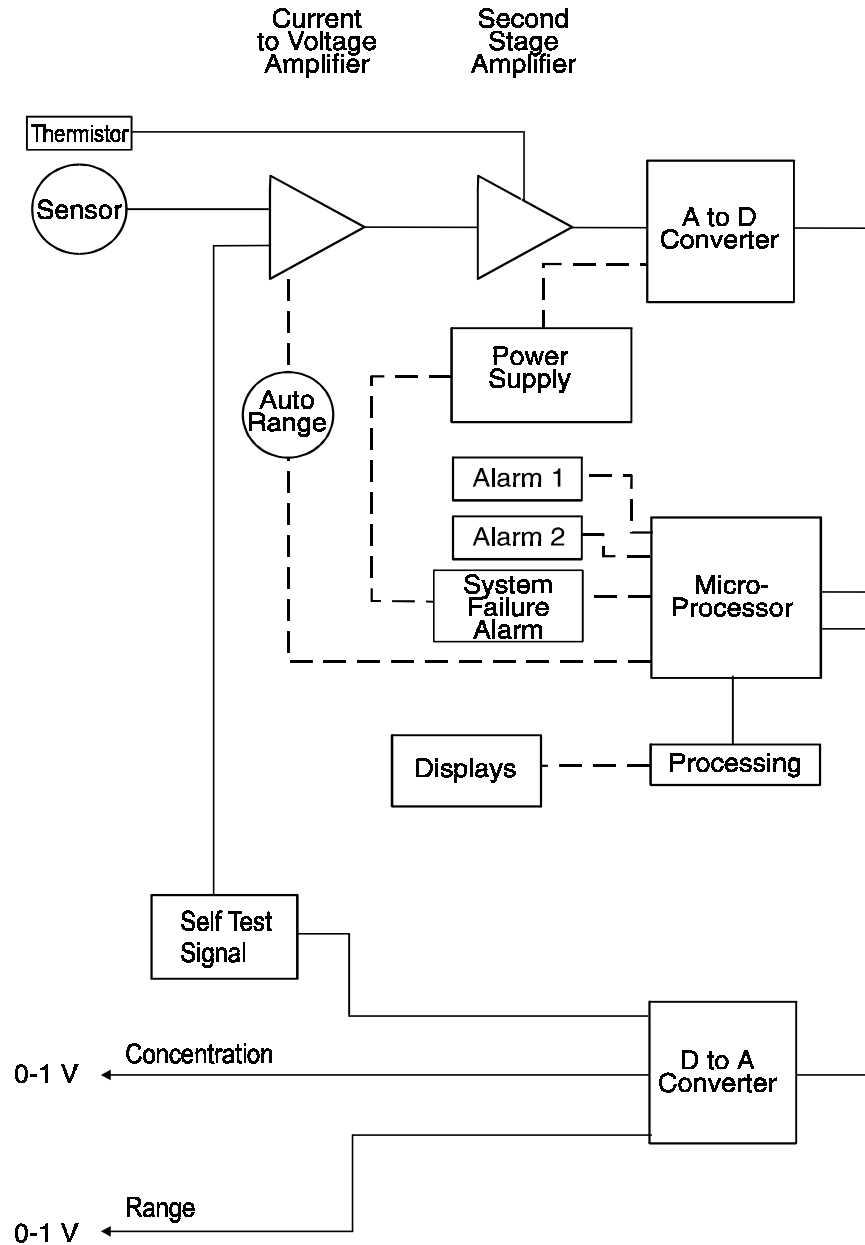

Figure 2-7: Block Diagram of the Model 3000P Electronics

In the presence of oxygen the cell generates a current. A current to voltage amplifier converts this current to a voltage, and then the voltage is amplified in the second stage amplifier.

The second stage amplifier also supplies temperature compensation for the oxygen sensor output. This amplifier circuit incorporates a thermistor, which is physically located in the cell block. The thermistor is a temperature dependent resistance that changes the gain of the amplifier in proportion to the temperature changes in the block. This change is inversely proportional to the change in the cell output due to the same temperature changes. The result is a signal that is temperature independent. The output from the second stage amplifier is sent to an 18 bit analog to digital converter controlled by the microprocessor.

The digital concentration signal along with input from the control panel is processed by the microprocessor, and appropriate control signals are directed to the display, alarms and communications port. The same digital information is also sent to a 12 bit digital to analog converter that produces the 0-1 V dc analog percent-of-range signal output and the analog range ID output. Models with the -MA option also have a 4-20 mA dc percent-of-range signal output and analog range ID output.

Signals from the power supply are also monitored by the microprocessor, and the system failure alarm is activated if a malfunction is detected.

## **Installation**

---

Installation of the Model 3000PA Analyzer includes:

1. Unpacking
2. Mounting
3. Gas connections
4. Electrical connections
5. Installing the Micro-Fuel Cell
6. Testing the system.

### **3.1 Unpacking the Analyzer**

The analyzer is shipped with all the materials you need to install and prepare the system for operation. Carefully unpack the analyzer and inspect it for damage. Immediately report any damage to the shipping agent.

### **3.2 Mounting the Analyzer**

The Model 3000PA is for indoor use in a general purpose area. It is NOT for use in hazardous environments of any type.

The standard model is designed for flush panel mounting. Figure 3-1 is an illustration of the 3000PA standard front panel and mounting bezel. There are four mounting holes—one in each corner of the rigid frame. The Drawings section in the rear of this manual contains outline dimensions and mounting hole spacing diagrams.

On special order, a 19" rack-mounting panel can be provided. For rack mounting, one or two 3000 series analyzers are flush-panel mounted on the rack panel. See Appendix for dimensions of the mounting panel.

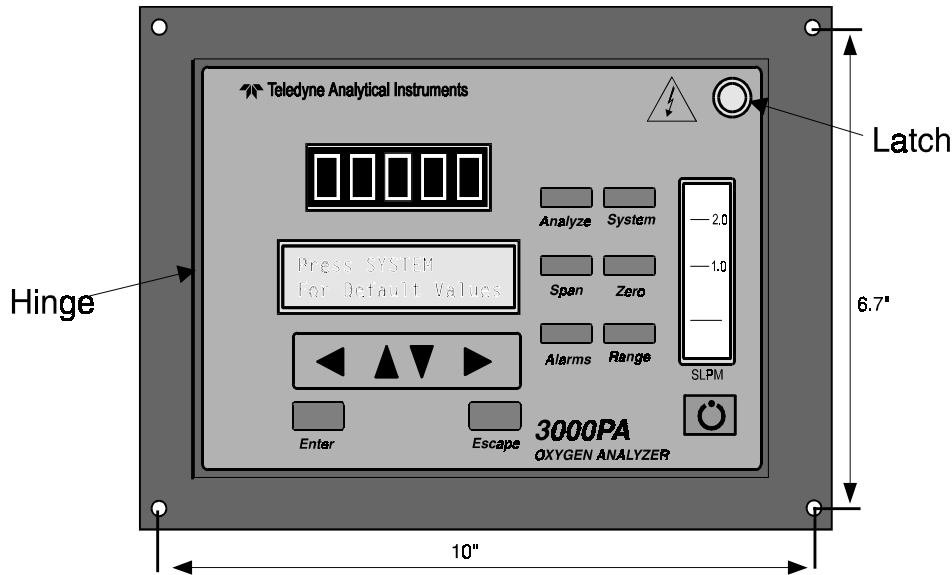

Figure 3-1: Front Panel of the Model 3000PA

All operator controls are mounted on the control panel, which is hinged on the left edge and doubles as the door that provides access to the sensor and cell block inside the instrument. The door is spring loaded and will swing open when the button in the center of the latch (upper right corner) is pressed all the way in with a narrow gauge tool (less than 0.18 inch wide), such as a small hex wrench or screwdriver. Allow clearance for the door to open in a 90-degree arc of radius 7.125 inches. See Figure 3-2.

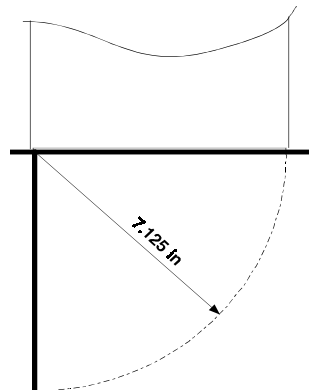

Figure 3-2: Required Front Door Clearance

### 3.3 Rear Panel Connections

Figure 3-3 shows the Model 3000PA rear panel. It contains all of the gas and electrical inputs and outputs. Some ports are optional equipment. Refer to page iii in the front of this manual for options included in your instrument. Be sure to note the instrument serial number.

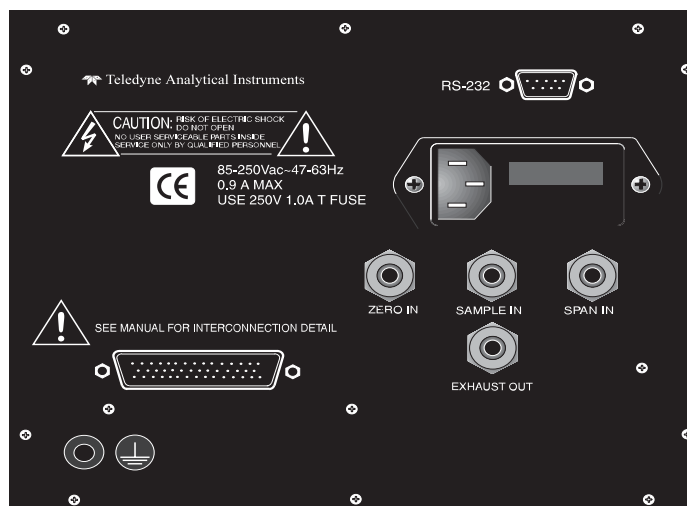

Figure 3-3: Rear Panel of the Model 3000PA



### 3.3.1 Gas Connections

Before using this instrument, it should be determined if the unit will be used for pressurized service or vacuum service and low pressure applications. Inspect the restrictor kit that came with the unit. The kit consists of two restrictors and a union for 1/4" diameter tubing. Notice that the two 1 3/4" long, 1/4" diameter tubing are restrictors. It has an open end and a closed end with a small circular orifice. The restrictor without the blue sticker is for low pressure and vacuum service. For high pressure (5 to 50 psig) applications, use the restrictor that has a blue sticker on the body.

For pressurized service, use the restrictor without the blue dot and union from the restrictor kit and attach it to the Sample In port. The small circular orifice should face away from the back of the unit (against the direction of gas flow). Use the restrictor without the blue dot sticker in the same manner for low pressure applications (less than 5 psig).

For vacuum service (5-10 in Hg), use the restrictor without the blue dot sticker and union but attach it to the Exhaust Out port. The small circular orifice should face toward the back of the unit (against the direction of gas flow).

Remove the blue sticker from the restrictor before using.

**WARNING:** *Operating the unit without restrictors can cause damage to the micro-fuel cell.*

The unit is manufactured with  $\frac{1}{4}$  inch tube fittings. Six millimeter adapters are supplied for metric system installations. For a safe connection:

1. Insert the tube into the tube fitting, and finger-tighten the nut until the tubing cannot be rotated freely, by hand, in the fitting. (This may require an additional  $\frac{1}{8}$  turn beyond finger-tight.)
2. Hold the fitting body steady with a backup wrench, and with another wrench rotate the nut another  $1\frac{1}{4}$  turns.

**SAMPLE IN:** In the standard model, gas connections are made at the SAMPLE IN and EXHAUST OUT connections. Calibration gases must be Tee'd into the Sample inlet with appropriate valves.

Ensure that the gas pressure is reasonably regulated. Pressures between 3 and 40 psig are acceptable as long as the pressure, once established, will keep the front panel flowmeter reading in an acceptable range (0.1 to 2.4 SLPM). Exact figures will depend on your process.

If greater flow is required for improved response time, install a bypass in the sampling system upstream of the analyzer input.

**Note:** If the unit is for vacuum service, the above numbers apply instead to the vacuum at the EXHAUST OUT connector, described below, with minus signs before the pressure readings.

**EXHAUST OUT:** Exhaust connections must be consistent with the hazard level of the constituent gases. Check Local, State, and Federal laws, and ensure that the exhaust stream vents to an appropriately controlled area if required.



**Note:** If the unit is for vacuum service, see *Sample In*, above, for gas pressure/flow considerations.

**ZERO IN and SPAN IN (Optional):** These are additional input ports for span gas and zero gas. There are electrically operated valves inside for automatic switching between sample and calibration gases. These valves are under control of the 3000P Electronics. They can be externally controlled only indirectly through the Remote Cal Inputs, described below.

Pressure, flow, and safety considerations are the same as prescribed for the SAMPLE IN inlet, above.



### 3.3.2 Electrical Connections

For safe connections, no uninsulated wiring should be able to come in contact with fingers, tools or clothing during normal operation.

**CAUTION:** Use Shielded Cables. Also, use plugs that provide excellent EMI/RFI protection. The plug case must be

**connected to the cable shield, and it must be tightly fastened to the analyzer with its fastening screws. Ultimately, it is the installer who ensures that the connections provide adequate EMI/RFI shielding.**

### 3.3.2.1 Primary Input Power

The power cord receptacle and fuse block are located in the same assembly. Insert the power cord into the power cord receptacle.

**CAUTION:** *Power is applied to the instrument's circuitry as long as the instrument is connected to the power source. The  switch on the front panel is for switching power on or off to the displays and outputs only.*



The universal power supply requires a 85–250 V ac, 47–63 Hz source.

**Fuse Installation:** The fuse block, at the right of the power cord receptacle, accepts US or European size fuses. A jumper replaces the fuse in whichever fuse receptacle is not used. Fuses are not installed at the factory. Be sure to install the proper fuse as part of installation. (See *Fuse Replacement* in chapter 5, *maintenance*.)

### 3.3.2.2 50-Pin Equipment Interface Connector

Figure 3-4 shows the pin layout of the Equipment Interface connector. The arrangement is shown as seen when the viewer faces the rear panel of the analyzer. The pin numbers for each input/output function are given where each function is described in the paragraphs below.

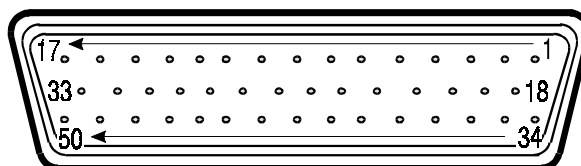

Figure 3-4: Equipment Interface Connector Pin Arrangement

**Analog Outputs:** There are four DC output signal pins—two pins per output. For polarity, see Table 3-1. The outputs are:

0–1 V dc % of Range: Voltage rises linearly with increasing oxygen, from 0 V at 0 % to 1 V at full scale. (Full scale = 100% of programmable range.)

0–1 V dc Range ID: 0.25 V = Low Range, 0.5 V = Medium Range, 0.75 V = High Range, 1 V = Air Cal Range.

- 4–20 mA dc % Range: (Optional) Current increases linearly with increasing oxygen, from 4 mA at 0 % to 20 mA at full scale. (Full scale = 100% of range.)
- 4–20 mA dc Range ID: (Optional) 8 mA = Low Range, 12 mA = Medium Range, 16 mA = High Range, 20 mA = Air Cal Range.



**Table 3-1: Analog Output Connections**

| Pin | Function                                 |
|-----|--|
| 3   | (Optional) + Range ID, 4-20 mA, floating |
| 4   | (Optional) – Range ID, 4-20 mA, floating |
| 5   | (Optional) + % Range, 4-20 mA, floating  |
| 6   | (Optional) – % Range, 4-20 mA, floating  |
| 8   | + Range ID, 0-1 V dc                     |
| 23  | – Range ID, 0-1 V dc, negative ground    |
| 24  | + % Range, 0-1 V dc                      |
| 7   | – % Range, 0-1 V dc, negative ground     |

**Alarm Relays:** The nine alarm-circuit connector pins connect to the internal alarm relay contacts. Each set of three pins provides one set of Form C relay contacts. Each relay has both normally open and normally closed contact connections. The contact connections are shown in Table 3-2. They are capable of switching up to 3 amperes at 250 V ac into a resistive load. The connectors are:

- Threshold Alarm 1:
  - Can be configured as high (actuates when concentration is above threshold), or low (actuates when concentration is below threshold).
  - Can be configured as failsafe or nonfailsafe.
  - Can be configured as latching or nonlatching.
  - Can be configured out (defeated).
- Threshold Alarm 2:
  - Can be configured as high (actuates when concentration is above threshold), or low (actuates when concentration is below threshold).
  - Can be configured as failsafe or nonfailsafe.
  - Can be configured as latching or nonlatching.
  - Can be configured out (defeated).
- System Alarm: Actuates when DC power supplied to circuits is unacceptable in one or more parameters. Permanently

configured as failsafe and latching. Cannot be defeated. Actuates if self test fails.

(Reset by pressing  button to remove power. Then press  again and any other button EXCEPT *System* to resume.

Further detail can be found in chapter 4, section 4-5.

**Table 3-2: Alarm Relay Contact Pins**

| Pin | Contact                                    |
|-----|--|
| 45  | Threshold Alarm 1, normally closed contact |
| 28  | Threshold Alarm 1, moving contact          |
| 46  | Threshold Alarm 1, normally open contact   |
| 42  | Threshold Alarm 2, normally closed contact |
| 44  | Threshold Alarm 2, moving contact          |
| 43  | Threshold Alarm 2, normally open contact   |
| 36  | System Alarm, normally closed contact      |
| 20  | System Alarm, moving contact               |
| 37  | System Alarm, normally open contact        |

**Digital Remote Cal Inputs:** Accept 0 V (off) or 24 V dc (on) inputs for remote control of calibration. (See *Remote Calibration Protocol* below.) See Table 3-3 for pin connections.

**Zero:** Floating input. 5 to 24 V input across the + and – pins puts the analyzer into the *Zero* mode. Either side may be grounded at the source of the signal. 0 to 1 volt across the terminals allows *Zero* mode to terminate when done. A synchronous signal must open and close the external zero valve appropriately. See *Remote Probe Connector*. (The –C option internal valves operate automatically.)

**Span:** Floating input. 5 to 24 V input across the + and – pins puts the analyzer into the *Span* mode. Either side may be grounded at the source of the signal. 0 to 1 volt across the terminals allows *Span* mode to terminate when done. A synchronous signal must open and close external span valve appropriately. See Figure 3-5 *Remote Probe Connector*. (The –C option internal valves operate automatically.)

**Cal Contact:** This relay contact is closed while analyzer is spanning and/or zeroing. (See *Remote Calibration Protocol* below.)

*Table 3-3: Remote Calibration Connections*

| Pin | Function      |
|-----|---------------|
| 9   | + Remote Zero |
| 11  | – Remote Zero |
| 10  | + Remote Span |
| 12  | – Remote Span |
| 40  | Cal Contact   |
| 41  | Cal Contact   |

**Remote Calibration Protocol:** To properly time the Digital Remote Cal Inputs to the Model 3000PA Analyzer, the customer's controller must monitor the Cal Relay Contact.

When the contact is OPEN, the analyzer is analyzing, the Remote Cal Inputs are being polled, and a zero or span command can be sent.

When the contact is CLOSED, the analyzer is already calibrating. It will ignore your request to calibrate, and it will not remember that request.

Once a zero or span command is sent, and acknowledged (contact closes), release it. If the command is continued until after the zero or span is complete, the calibration will repeat and the Cal Relay Contact (CRC) will close again.

For example:

- 1) Test the CRC. When the CRC is open, Send a zero command until the CRC closes (The CRC will quickly close.)
- 2) When the CRC closes, remove the zero command.
- 3) When CRC opens again, send a span command until the CRC closes. (The CRC will quickly close.)
- 4) When the CRC closes, remove the span command.

When CRC opens again, zero and span are done, and the sample is being analyzed.

**Note:** The Remote Valve connections (described below) provides signals to ensure that the zero and span gas valves will be controlled synchronously. If you have the –C Internal valve option—which includes additional zero and span gas inputs—the 3000P automatically regulates the zero, span and sample gas flow.

**Range ID Relays:** Four dedicated Range ID relay contacts. The first three ranges are assigned to relays in ascending order—Low range is as-

signed to Range 1 ID, Medium range is assigned to Range 2 ID, and High range is assigned to Range 3 ID. The fourth range is reserved for the Air Cal Range (25%). Table 3-4 lists the pin connections.

**Table 3-4: Range ID Relay Connections**

| Pin | Function                     |
|-----|------------------------------|
| 21  | Range 1 ID Contact           |
| 38  | Range 1 ID Contact           |
| 22  | Range 2 ID Contact           |
| 39  | Range 2 ID Contact           |
| 19  | Range 3 ID Contact           |
| 18  | Range 3 ID Contact           |
| 34  | Range 4 ID Contact (Air Cal) |
| 35  | Range 4 ID Contact (Air Cal) |

**Network I/O:** A serial digital input/output for local network protocol. At this printing, this port is not yet functional. It is to be used for future options to the instrument. Pins 13 (+) and 29 (-).

**Remote Valve Connections:** The 3000PA is a single-chassis instrument, which has no Remote Valve Unit. Instead, the Remote Valve connections are used as a method for directly controlling external sample/zero/span gas valves. See Figure 3-5.

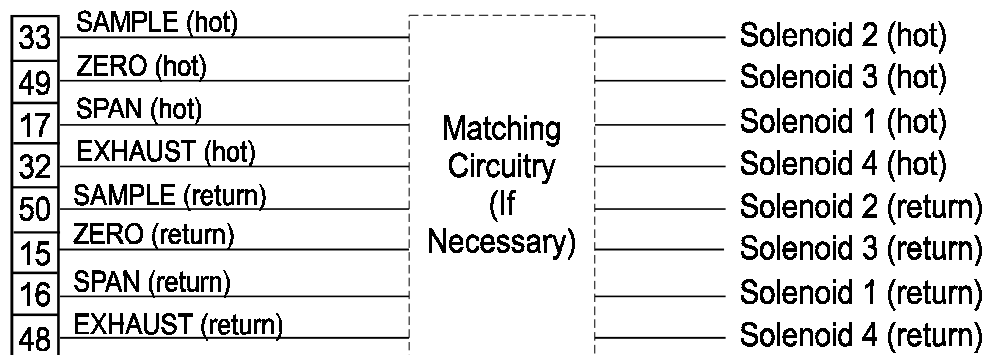

*Figure 3-5: Remote Valve Connections*

The voltage from these outputs is nominally 0 V for the OFF and 15 V dc for the ON conditions. The maximum combined current that can be pulled from these output lines is 100 mA. (If two lines are ON at the same time, each must be limited to 50 mA, etc.) If more current and/or a different voltage is required, use a relay, power amplifier, or other matching circuitry to provide the actual driving current.

In addition, each individual line has a series FET with a nominal ON resistance of 5 ohms (9 ohms worst case). This can limit the obtainable voltage, depending on the load impedance applied. See Figure 3-6.

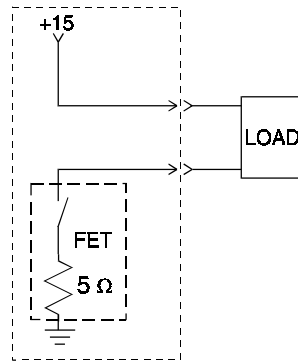

Figure 3-6: FET Series Resistance

**3.3.2.3 RS-232 Port:** The digital signal output is a standard RS-232 serial communications port used to connect the analyzer to a computer, terminal, or other digital device. It requires a standard 9-pin D connector.

The data is status information, in digital form, updated every two seconds. Status is reported in the following order:

- The concentration in percent
- The range in use (HI, MED, LO)
- The span of the range (0-10 %, etc)
- Which alarms—if any—are disabled (AL-x DISABLED)
- Which alarms—if any—are tripped (AL-x ON).

Each status output is followed by a carriage return and line feed.

Four input functions using RS-232 have been implemented to date. They are described in Table 3-1.

**Table 3-1: Commands via RS-232 Input**

| Command           | Description   |
|-------------------|---|
| <b>as</b> <enter> | Immediately starts an autospan.   |
| <b>az</b> <enter> | Immediately starts an autozero.   |
| <b>co</b> <enter> | Reports "Raw Cell Output" (current output of the sensor itself) in $\mu\text{A}$ . For example— |

Raw Cell Output: 99  $\mu\text{A}$ .

**st<enter>**            Toggling input. Stops/Starts any status message output from the RS-232, until **st<enter>** is sent again.

The RS-232 protocol allows some flexibility in its implementation. Table 3-2 lists certain RS-232 values that are required by the 3000PA implementation.

**Table 3-2: Required RS-232 Options**

| Parameter        | Setting   |
|------------------|-----------|
| Baud             | 2400      |
| Byte             | 8 bits    |
| Parity           | none      |
| Stop Bits        | 1         |
| Message Interval | 2 seconds |

### 3.4 Installing the Micro-Fuel Cell

The Micro-Fuel Cell is not installed in the cell block when the instrument is shipped. It must be installed before the analyzer is placed in service.

Once it is expended, or if the cell is exposed to air for too long, the Micro-Fuel Cell will need to be replaced. The cell could also require replacement if the instrument has been idle for too long.

When the micro-Fuel Cell needs to be installed or replaced, follow the procedures in chapter 5, *Maintenance*, for removing and installing cells.

### 3.5 Testing the System

Before plugging the instrument into the power source:

- Check the integrity and accuracy of the gas connections. Make sure there are no leaks.
- Check the integrity and accuracy of the electrical connections. Make sure there are no exposed conductors.
- Check that sample pressure is between 3 and 40 psig, according to the requirements of your process.

Power up the system, and test it by performing the following operations:

1. Repeat the Self-Diagnostic Test as described in chapter 4, section 4.3.5.



## Operation

---

### 4.1 Introduction

Once the analyzer has been installed, it can be configured for your application. To do this you will:

- Set system parameters:
  - Establish a security password, if desired, requiring Operator to log in.
  - Establish and start an automatic calibration cycle, if desired.
- Calibrate the instrument.
- Define the three user selectable analysis ranges. Then choose autoranging or select a fixed range of analysis, as required.
- Set alarm setpoints, and modes of alarm operation (latching, failsafe, etc).

Before you configure your 3000PA these default values are in effect:

**Ranges:** LO = 1 %, MED = 5 %, HI = 10 %

**Auto Ranging:** ON

**Alarm Relays:** Defeated, 10 %, HI, Not failsafe, Not latching

**Zero:** Auto, every 0 days at 0 hours

**Span:** Auto, at 20.9 %, every 0 days at 0 hours

If you choose not to use password protection, the default password is automatically displayed on the password screen when you start up, and you simply press *Enter* for access to all functions of the analyzer.

## 4.2 Using the Data Entry and Function Buttons

**Data Entry Buttons:** The < > arrow buttons select options from the menu currently displayed on the VFD screen. The selected option blinks.

When the selected option includes a modifiable item, the  $\Delta\nabla$  arrow buttons can be used to increment or decrement that modifiable item.

The *Enter* button is used to accept any new entries on the VFD screen. The *Escape* button is used to abort any new entries on the VFD screen that are not yet accepted by use of the *Enter* button.

Figure 4-1 shows the hierarchy of functions available to the operator via the function buttons. The six function buttons on the analyzer are:

- **Analyze.** This is the normal operating mode. The analyzer monitors the oxygen content of the sample, displays the percent of oxygen, and warns of any alarm conditions.
- **System.** The system function consists of six subfunctions that regulate the internal operations of the analyzer:
  - Set LCD screen contrast
  - Setup Auto-Cal
  - Assign Password
  - Initiate Self-Test
  - Check software version
  - View sensor output
  - Log out.
- **Zero.** Used to set up a zero calibration.
- **Span.** Used to set up a span calibration.
- **Alarms.** Used to set the alarm setpoints and determine whether each alarm will be active or defeated, HI or LO acting, latching, and/or failsafe.
- **Range.** Used to set up three analysis ranges that can be switched automatically with auto-ranging or used as individual fixed ranges.

**Contrast Function is *DISABLED***  
(Refer to Section 1.6)



Any function can be selected at any time by pressing the appropriate button (unless password restrictions apply). The order as presented in this manual is appropriate for an initial setup.

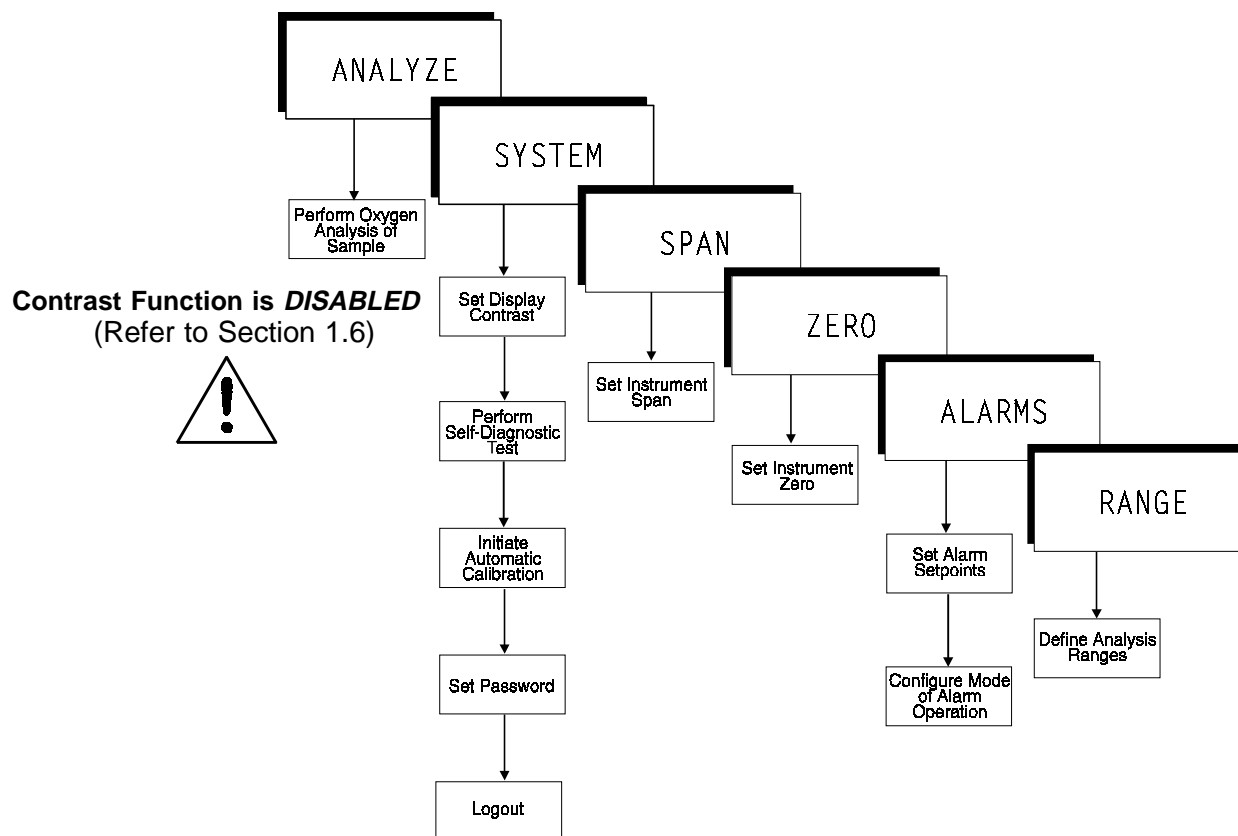

Figure 4-1: Hierarchy of Functions and Subfunctions

Each of these functions is described in greater detail in the following procedures. The VFD screen text that accompanies each operation is reproduced, at the appropriate point in the procedure, in a Monospaced type style. Pushbutton names are printed in *Oblique* type.

### 4.3 The System Function

The subfunctions of the *System* function are described below. Specific procedures for their use follow the descriptions:

- **Auto-Cal:** Used to define an automatic calibration sequence and/or start an Auto-Cal.
- **PSWD:** Security can be established by choosing a 5 digit password (PSWD) from the standard ASCII character set. (See *Installing or Changing a Password*, below, for a table of ASCII characters available.) Once a unique password is assigned and

activated, the operator **MUST** enter the **UNIQUE** password to gain access to set-up functions which alter the instrument's operation, such as setting the instrument span or zero setting, adjusting the alarm setpoints, or defining analysis ranges.

After a password is assigned, the operator must **log out** to activate it. Until then, anyone can continue to operate the instrument without entering the new password.

**Only one password can be defined.** Before a unique password is assigned, the system assigns TBEAI by default. This allows access to anyone. After a unique password is assigned, to defeat the security, the password must be changed back to TBEAI.

- **Logout:** Logging out prevents an unauthorized tampering with analyzer settings.
- **More:** Select and enter More to get a new screen with additional subfunctions listed.
- **Self-Test:** The instrument performs a self-diagnostic test to check the integrity of the power supply, output boards and amplifiers.
- **Version:** Displays Manufacturer, Model, and Software Version of instrument.

#### 4.3.1 Setting the Display

Contrast Function is **DISABLED**  
(Refer to Section 1.6)



If you cannot read anything on the display after first powering up:

1. Observe LED readout.
  - a. If LED meter reads all **eights and periods**, go to step 3.
  - b. If LED meter displays anything else, go to step 2.
2. Press  button twice to turn Display OFF and ON again. LED meter should now read all eights and periods. Go to step 3.

### 4.3.2 Setting up an Auto-Cal

When proper automatic valving is connected (see chapter 3, *installation*), the Analyzer can cycle itself through a sequence of steps that automatically zero and span the instrument.

**Note:** If you require highly accurate Auto-Cal timing, use external Auto-Cal control where possible. The internal clock in the Model 3000PA is accurate to 2-3 %. Accordingly, internally scheduled calibrations can vary 2-3 % per day.

To setup an Auto-Cal cycle:

Choose *System* from the Function buttons. The VFD will display five subfunctions.



**Contrast Function is *DISABLED*** Contrast Auto-Cal  
(Refer to Section 1.6) PSWD Logout More

Use <> arrows to blink Auto-Cal, and press *Enter*. A new screen for Span/Zero set appears.

```
Span OFF Nxt: 0d 0h
Zero OFF Nxt: 0d 0h
```

Press <> arrows to blink Span (or Zero), then press *Enter* again. (*You won't be able to set OFF to ON if a zero interval is entered.*) A Span Every ... (or Zero Every ...) screen appears.

```
Span Every 0 d
Start 0 h from now
```

Use  $\Delta\nabla$  arrows to set an interval value, then use <> arrows to move to the start-time value. Use  $\Delta\nabla$  arrows to set a start-time value.

To turn ON the Span and/or Zero cycles (to activate Auto-Cal): Press *System* again, choose Auto-Cal, and press *Enter* again. When the Span/Zero screen appears, use the <> arrows to blink the Span (or Zero) OFF/ON field. Use  $\Delta\nabla$  arrows to set the OFF/ON field to ON. You can now turn these fields ON because there is a nonzero span interval defined.

### 4.3.3 Password Protection

If a password is assigned, then setting the following system parameters can be done only after the password is entered: **span** and **zero** settings, **alarm** setpoints, analysis **range** definitions, switching between **autoranging** and manual override, setting up an **auto-cal**, and assigning a new **password**. However, the instrument can still be used for analysis or for initiating a self-test without entering the password.

If you have decided not to employ password security, use the default password TBEAI. This password will be displayed automatically by the microprocessor. The operator just presses the Enter key to be allowed total access to the instrument's features.

**NOTE: If you use password security, it is advisable to keep a copy of the password in a separate, safe location.**

#### 4.3.3.1 Entering the Password

To install a new password or change a previously installed password, you must key in and *ENTER* the old password first. If the default password is in effect, pressing the *ENTER* button will enter the default TBEAI password for you.

Press *System* to enter the *System* mode.

Contrast Auto-Cal  
PSWD Logout More

**Contrast Function is *DISABLED***  
(Refer to Section 1.6)



Use the < > arrow keys to scroll the blinking over to PSWD, and press *Enter* to select the password function. Either the default TBEAI password or AAAAA place holders for an existing password will appear on screen depending on whether or not a password has been previously installed.

T B E A I  
Enter PWD

or

A A A A A  
Enter PWD

The screen prompts you to enter the current password. If you are not using password protection, press *Enter* to accept TBEAI as the default password. If a password has been previously installed, enter the password using the < > arrow keys to scroll back and forth between letters, and the  $\Delta \nabla$  arrow keys to change the letters to the proper password. Press *Enter* to enter the password.

If the password is accepted, the screen will indicate that the password restrictions have been removed and you have clearance to proceed.

PSWD Restrictions  
Removed

In a few seconds, you will be given the opportunity to change this password or keep it and go on.

```
Change Password?
<ENT>=Yes  <ESC>=No
```

Press *Escape* to move on, or proceed as in *Changing the Password*, below.

#### 4.3.3.2 Installing or Changing the Password

If you want to install a password, or change an existing password, proceed as above in *Entering the Password*. When you are given the opportunity to change the password:

```
Change Password?
<ENT>=Yes  <ESC>=No
```

Press *Enter* to change the password (either the default TBEAI or the previously assigned password), or press *Escape* to keep the existing password and move on.

If you chose *Enter* to change the password, the password assignment screen appears.

```
T B E A I
<ENT> To Proceed
```

or

```
A A A A A
<ENT> To Proceed
```

Enter the password using the < > arrow keys to move back and forth between the existing password letters, and the  $\Delta\nabla$  arrow keys to change the letters to the new password. The full set of 94 characters available for password use are shown in the table below.

#### Characters Available for Password Definition:

|   |   |   |   |   |    |   |   |   |   |
|---|---|---|---|---|----|---|---|---|---|
| A | B | C | D | E | F  | G | H | I | J |
| K | L | M | N | O | P  | Q | R | S | T |
| U | V | W | X | Y | Z  | [ | ¥ | ] | ^ |
| _ | ` | a | b | c | d  | e | f | g | h |
| i | j | k | l | m | n  | o | p | q | r |
| s | t | u | v | w | x  | y | z | { |   |
| } | → | ! | " | # | \$ | % | & | ' | ( |
| ) | * | + | , | - | .  | / | 0 | 1 | 2 |
| 3 | 4 | 5 | 6 | 7 | 8  | 9 | : | ; | < |
| = | > | ? | @ |   |    |   |   |   |   |

When you have finished typing the new password, press *Enter*. A verification screen appears. The screen will prompt you to retype your password for verification.

```

A A A A A
Retype PWD To Verify

```

Wait a moment for the entry screen. You will be given clearance to proceed.

```

A A A A A
<ENT> TO Proceed

```

Use the arrow keys to retype your password and press *Enter* when finished. Your password will be stored in the microprocessor and the system will immediately switch to the *Analyze* screen, and you now have access to all instrument functions.

If all alarms are defeated, the *Analyze* screen appears as:

```

0.0    % Anlz
Range: 0 - 10

```

If an alarm is tripped, the second line will change to show which alarm it is:

```

0.0    % Anlz
AL-1

```

**Note:** If you log off the system using the logout function in the system menu, you will now be required to re-enter the password to gain access to Span, Zero, Alarm, and Range functions.

#### 4.3.4 Logout

The Logout function provides a convenient means of leaving the analyzer in a password protected mode without having to shut the instrument off. By entering Logout, you effectively log off the instrument leaving the system protected against use until the password is reentered. To log out, press the *System* button to enter the *System* function.

```

Contrast Auto-Cal   Contrast Function is DISABLED
PSWD Logout More   (Refer to Section 1.6)

```



Use the < > arrow keys to position the blinking over the Logout function, and press *Enter* to Log out. The screen will display the message:

```

Protected Until
Password Reentered

```

### 4.3.5 System Self-Diagnostic Test

The Model 3000PA has a built-in self-diagnostic testing routine. Pre-programmed signals are sent through the power supply, output board and sensor circuit. The return signal is analyzed, and at the end of the test the status of each function is displayed on the screen, either as OK or as a number between 1 and 3. (See *System Self Diagnostic Test* in chapter 5 for number code.)

The self diagnostics are run automatically by the analyzer whenever the instrument is turned on, but the test can also be run by the operator at will. To initiate a self diagnostic test during operation:

Press the *System* button to start the *System* function.



**Contrast Function is *DISABLED*** Contrast Auto-Cal  
(Refer to Section 1.6) PSWD Logout More

Use the < > arrow keys to blink *More*, then press *Enter*.

Version Self-Test  
Cell Output: ### µA

Use the < > arrow keys again to move the blinking to the *Self-Test* function. The screen will follow the running of the diagnostic.

RUNNING DIAGNOSTIC  
Testing Preamp - 83

During preamp testing there is a countdown in the lower right corner of the screen. When the testing is complete, the results are displayed.

Power: OK Analog: OK  
Preamp: 3

The module is functioning properly if it is followed by OK. A number indicates a problem in a specific area of the instrument. Refer to Chapter 5 *Maintenance and Troubleshooting* for number-code information. The results screen alternates for a time with:

Press Any Key  
To Continue...

Then the analyzer returns to the initial *System* screen.

### 4.3.6 Version Screen

Move the < > arrow key to *More* and press *Enter*. With *Version* blinking, press *Enter*. The screen displays the manufacturer, model, and software version information.

## 4.4 The Span Functions

The analyzer is calibrated using span gas.

**NOTE:** *Zero is not necessary for Percent (%) level measurements.*

*Additional information on ZERO functions is provided in the Appendix A-6 of this manual.*

Although the instrument can be spanned using air, a span gas with a known oxygen concentration in the range of 70–90% of full scale of the range of interest is recommended. Since the oxygen concentration in air is 20.9 %, the cell can take longer to recover if the instrument is used for less than 1 % oxygen analysis immediately following calibration in air.

Connect the calibration gases to the analyzer according to the instructions given in Section 3.4.1, *Gas Connections*, observing all the prescribed precautions.

**Shut off the gas pressure before connecting it to the analyzer, and be sure to limit the pressure to 40 psig or less when turning it back on.**



Readjust the gas pressure into the analyzer until the flowrate (as read on the analyzer's SLPM flowmeter) settles between 0.5 and 2.4 SLPM (approximately 1-5 scfh).

If you are using password protection, you will need to enter your password to gain access to either of these functions. Follow the instructions in section 4.3.3 to enter your password. Once you have gained clearance to proceed, you can enter the *Zero* or *Span* function.

### 4.4.1. Cell Failure

When the sensor in the 3000PA begins to fail, the analyzer will usually require more and more frequent calibration. If the 3000PA analysis readings drift downward uncharacteristically, try recalibration. If recalibration raises the readings temporarily, the cell may be failing.

You can check the output of the cell itself by going to the *System* function, selecting *More*, and pressing *Enter*. The cell output reading will be on the second line of the display.

Version Self-Test

Cell Output: ### µA

The “good” reading depends on the class of cell your analyzer is using.

Although the B-1 cell is standard in the 3000PA, **check *Specific Model Information* in the Front Matter in this manual for the class of cell you**

**purchased.** Then check *Cell Replacement* in chapter 5 *Maintenance*, and do the prescribed calculations.

If a weak cell is indicated, replace the cell as described there in chapter 5.

#### 4.4.2 Span Cal

The *Span* button on the front panel is used to span calibrate the analyzer. Span calibration can be performed using the **automatic** mode, where an internal algorithm compares consecutive readings from the sensor to determine when the output matches the span gas concentration. Span calibration can also be performed **manual** mode, where the operator determines when the span concentration reading is acceptable and then manually exits the function.

##### 4.4.2.1 Auto Mode Spanning

Press *Span* to enter the span function. The screen that appears allows you to select whether the span calibration is to be performed automatically or manually. Use the  $\Delta\nabla$  arrow keys to toggle between AUTO and MAN span settling. Stop when AUTO appears, blinking, on the display.

```
Span: Settling: AUTO
<ENT> For Next
```

Press *Enter* to move to the next screen.

```
Span Val: 20.90
<ENT>Span <UP>Mod #
```

Use the  $\Delta\nabla$  arrow keys to enter the oxygen-concentration mode. Use the  $\triangleleft \triangleright$  arrow keys to blink the digit you are going to modify. Use the  $\Delta\nabla$  arrow keys again to change the value of the selected digit. When you have finished typing in the concentration of the span gas you are using (20.90 if you are using air), press *Enter* to begin the Span calibration.

```
##### % Span
Slope=##### ppm/s
```

The beginning span value is shown in the upper left corner of the display. As the span reading settles, the screen displays and updates information on Slope. Spanning automatically ends when the slope is less than 1/50 of the displayed value of the oxygen concentration (in ppm) for three minutes. Then the instrument automatically returns to the analyze mode.

### 4.4.2.2 Manual Mode Spanning

Press *Span* to start the *Span* function. The screen that appears allows you to select whether the span calibration is to be performed automatically or manually.

```
Span: Settling:MAN
<ENT> For Next
```

Use the  $\Delta\nabla$  keys to toggle between AUTO and MAN span settling. Stop when MAN appears, blinking, on the display. Press *Enter* to move to the next screen.

```
Span Val: 20.90
<ENT>Span <UP>Mod #
```

Press  $\Delta$  (<UP>) to permit modification (Mod #) of span value.

Use the arrow keys to enter the oxygen concentration of the span gas you are using (20.90 if you are using air). The  $\leftarrow$   $\rightarrow$  arrows chose the digit, and the  $\Delta\nabla$  arrows choose the value of the digit.

Press *Enter* to enter the span value into the system and begin the span calibration.

Once the span has begun, the microprocessor samples the output at a predetermined rate. It calculates the difference between successive samplings and displays this difference as *Slope* on the screen. It takes several seconds for the first *Slope* value to display. *Slope* indicates rate of change of the Span reading. It is a sensitive indicator of stability.

```
#### % Span
Slope=#### ppm/s
```

When the Span value displayed on the screen is sufficiently stable, press *Enter*. (Generally, when the Span reading changes by 1 % or less of the full scale of the range being calibrated for a period of five minutes it is sufficiently stable.) Once *Enter* is pressed, the Span reading changes to the correct value. The instrument then automatically enters the *Analyze* function.

## 4.5 The Alarms Function

The Model 3000PA is equipped with 2 fully adjustable concentration alarms and a system failure alarm. Each alarm has a relay with a set of form "C" contacts rated for 3 amperes resistive load at 250 V ac. See Figure in Chapter 3, *Installation* and/or the Interconnection Diagram included at the back of this manual for relay terminal connections.

---

The system failure alarm has a fixed configuration described in chapter 3 *Installation*.

The concentration alarms can be configured from the front panel as either *high* or *low* alarms by the operator. The alarm modes can be set as *latching* or *non-latching*, and either *failsafe* or *non-failsafe*, or, they can be *defeated* altogether. The setpoints for the alarms are also established using this function.

Decide how your alarms should be configured. The choice will depend upon your process. Consider the following four points:

1. Which if any of the alarms are to be high alarms and which if any are to be low alarms?

Setting an alarm as HIGH triggers the alarm when the oxygen concentration rises above the setpoint. Setting an alarm as LOW triggers the alarm when the oxygen concentration falls below the setpoint.

Decide whether you want the alarms to be set as:

- Both high (high and high-high) alarms, or
- One high and one low alarm, or
- Both low (low and low-low) alarms.

2. Are either or both of the alarms to be configured as failsafe?

In failsafe mode, the alarm relay de-energizes in an alarm condition. For non-failsafe operation, the relay is energized in an alarm condition. You can set either or both of the concentration alarms to operate in failsafe or non-failsafe mode.

3. Are either of the alarms to be latching?

In latching mode, once the alarm or alarms trigger, they will remain in the alarm mode even if process conditions revert back to non-alarm conditions. This mode requires an alarm to be recognized before it can be reset. In the non-latching mode, the alarm status will terminate when process conditions revert to non-alarm conditions.

4. Are either of the alarms to be defeated?

The defeat alarm mode is incorporated into the alarm circuit so that maintenance can be performed under conditions which would normally activate the alarms.

The defeat function can also be used to reset a latched alarm. (See procedures, below.)

If you are using password protection, you will need to enter your password to access the alarm functions. Follow the instructions in section 4.3.3 to enter your password. Once you have clearance to proceed, enter the *Alarm* function.

Press the *Alarm* button on the front panel to enter the *Alarm* function. Make sure that AL-1 is blinking.

```
AL-1    AL-2
Choose Alarm
```

Set up alarm 1 by moving the blinking over to AL-1 using the < > arrow keys. Then press *Enter* to move to the next screen.

```
AL-1 1.00 % HI
Dft-N Fs-N Ltch-N
```

Five parameters can be changed on this screen:

- Value of the alarm setpoint, AL-1 ##### % (oxygen)
- Out-of-range direction, HI or LO
- Defeated? Dft-**Y/N** (Yes/No)
- Failsafe? Fs-**Y/N** (Yes/No)
- Latching? Ltch-**Y/N** (Yes/No).
- To define the setpoint, use the < > arrow keys to move the blinking over to AL-1 #####. Then use the  $\Delta \nabla$  arrow keys to change the number. Holding down the key speeds up the incrementing or decrementing. (Remember, the setpoint units are percent-of-oxygen.)
- To set the other parameters use the < > arrow keys to move the blinking over to the desired parameter. Then use the  $\Delta \nabla$  arrow keys to change the parameter.
- Once the parameters for alarm 1 have been set, press *Alarms* again, and repeat this procedure for alarm 2 (AL-2).
- To reset a latched alarm, go to Dft- and then press either  $\Delta$  two times or  $\nabla$  two times. (Toggle it to **Y** and then back to **N**.)

–OR–

Go to Ltch- and then press either  $\Delta$  two times or  $\nabla$  two times. (Toggle it to **N** and back to **Y**.)

## 4.6 The *Range* Function

The Range function allows the operator to program up to three concentration ranges to correlate with the DC analog outputs. If no custom ranges are defined by the user, the instrument defaults to:

Low = 0–1.00 %  
Med = 0–5.00 %  
High = 0–10.00 %.

The Model 3000PA is set at the factory to default to autoranging. In this mode, the microprocessor automatically responds to concentration changes by switching ranges for optimum readout sensitivity. If the current range limits are exceeded, the instrument will automatically shift to the next higher range. If the concentration falls slightly below full scale of the next lower range, the instrument will switch to that range. A corresponding shift in the DC percent-of-range output, and in the range ID outputs, will be noticed.

The autoranging feature can be overridden so that analog output stays on a fixed range regardless of the oxygen concentration detected. If the concentration exceeds the upper limit of the range, the DC output will saturate at 1 V dc.

However, the digital readout and the RS-232 output of the concentration are unaffected by the fixed range. They continue to read accurately with full precision. See *Front Panel* description in Chapter 1.

### 4.6.1 Setting the Analog Output Ranges

To set the ranges, enter the range function mode by pressing the *Range* button on the front panel.

L-1.00 M-5.00  
H-10.00 Mode-AUTO

Use the < > arrow keys to blink the range to be set: low (L), medium (M), or high (H).

Use the  $\Delta \nabla$  arrow keys to enter the upper value of the range (all ranges begin at 0 %). Repeat for each range you want to set. Press *Enter* to accept the values and return to *Analyze* mode. (See note below.)

**Note:** The ranges must be increasing from low to high. For example, if range 1 is set as 0–1 % and range 2 is set as 0–10 %, range 3 cannot be set as 0–5 % since it is lower than range 2.

### 4.6.2 Autoranging Analysis

Set your analysis ranges as in 4.6.1, above. Leave Mode in Auto, or use the arrow buttons to change back to Auto.

When operating in autoranging, if the oxygen concentration in your sample goes ABOVE your HIGHEST range setting, the analyzer will go into the special 25 % cal range.

However, if one of your range settings is below 0-25 % and another is set above 0-25 %, the special 0-25 % Air Cal range will NOT activate as the oxygen level goes through 25 %. Nevertheless, if the oxygen concentration in your sample goes ABOVE your HIGHEST range setting, the analyzer will THEN drop back down into the special 25 % cal range.

Once the oxygen concentration drops back down into your highest range setting, the analyzer will automatically switch back to that range.

**CAUTION: While the analyzer is in the Air Cal range, the oxygen reading cannot go over 25 %, even if the oxygen concentration is higher than 25 %.**

### 4.6.3 Fixed Range Analysis

The autoranging mode of the instrument can be overridden, forcing the analyzer DC outputs to stay in a single predetermined range.

To switch from autoranging to fixed range analysis, enter the range function by pressing the *Range* button on the front panel.

Use the < > arrow keys to move the blinking over AUTO.

Use the  $\Delta \nabla$  arrow keys to switch from AUTO to FX/LO, FX/MED, or FX/HI to set the instrument on the desired fixed range (low, medium, or high).

L-1.00 M-5.00  
H-10.00 Mode-FX/LO

or

L-1.00 M-5.00  
H-10.00 Mode-FX/MED

or

L-1.00 M-5.00  
H-10.00 Mode-FX/HI

Press *Escape* to re-enter the *Analyze* mode using the fixed range.

**NOTE:** When performing analysis on a fixed range, if the oxygen concentration rises above the upper limit (or default value) as established by the operator for that particular range, the output saturates at 1 V dc. However, the digital readout and the RS-232 output continue to read the true value of the oxygen concentration regardless of the analog output range.

## 4.7 The *Analyze* Function

Normally, all of the functions automatically switch back to the *Analyze* function when they have completed their assigned operations. Pressing the *Escape* button in many cases also switches the analyzer back to the *Analyze* function. Alternatively, you can press the *Analyze* button at any time to return to analyzing your sample.

## 4.8 Signal Output

The standard Model 3000PA Percent Oxygen Analyzer is equipped with two 0–1 V dc analog output terminals accessible on the back panel (one concentration and one range ID). The –MA option also has two isolated 4–20 mA dc current outputs (one concentration and one range ID).

See *Rear Panel* in Chapter 3, *Installation*, for illustration.

The signal output for concentration is linear over the currently selected analysis range. For example, if the analyzer is set on range that was defined as 0–10 % O<sub>2</sub>, then the output would be:

| % O <sub>2</sub> | Voltage Signal Output (V dc) | Current Signal Output (mA dc) |
|------------------|------------------------------|-------------------------------|
| 0                | 0.0                          | 4.0                           |
| 1                | 0.1                          | 5.6                           |
| 2                | 0.2                          | 7.2                           |
| 3                | 0.3                          | 8.8                           |
| 4                | 0.4                          | 10.4                          |
| 5                | 0.5                          | 12.0                          |
| 6                | 0.6                          | 13.6                          |
| 7                | 0.7                          | 15.2                          |
| 8                | 0.8                          | 16.8                          |
| 9                | 0.9                          | 18.4                          |
| 10               | 1.0                          | 20.0                          |

The analog output signal has a voltage which depends on the oxygen concentration AND the currently activated analysis range. To relate the signal output to the actual concentration, it is necessary to know what range the instrument is currently on, especially when the analyzer is in the autoranging mode.

To provide an indication of the range, a second pair of analog output terminals are used. They generate a steady preset voltage (or current if you have current outputs) to represent a particular range. The following table gives the range ID output for each analysis range:

| <b>Range</b> | <b>Voltage (V)</b> | <b>Current (mA)</b> |
|--------------|--------------------|---------------------|
| LO           | 0.25               | 8                   |
| MED          | 0.50               | 12                  |
| HI           | 0.75               | 16                  |
| CAL (0-25%)  | 1.00               | 20                  |





---

## Maintenance

---

### 5.1 Routine Maintenance

Aside from normal cleaning and checking for leaks at the gas connections, routine maintenance is limited to replacing Micro-Fuel cells and fuses, and recalibration. For recalibration, see Section 4.4 *Calibration*.



**WARNING:** SEE WARNINGS ON THE TITLE PAGE OF THIS MANUAL.

### 5.2 Cell Replacement

The Micro-Fuel Cell is a sealed electrochemical transducer with no electrolyte to change or electrodes to clean. When the cell reaches the end of its useful life, it is replaced. The spent fuel cell should be discarded according to local regulations. This section describes fuel cell care as well as when and how to replace it.

#### 5.2.1 Storing and Handling Replacement Cells

To have a replacement cell available when it is needed, TAI recommends that one spare cell be purchased 4-5 months after commissioning the 3000PA, or shortly before the end of the cell warranty period.



**CAUTION:** *Do not stockpile cells. The warranty period starts on the day of shipment.*

The spare cell should be carefully stored in an area that is not subject to large variations in ambient temperature (75 °F nominal) or to rough handling.



**WARNING:** *THE SENSOR USED IN THE MODEL 3000PA PERCENT OXYGEN ANALYZER USES ELECTROLYTES WHICH CONTAIN TOXIC SUBSTANCES, MAINLY*

---

*LEAD AND POTASSIUM HYDROXIDE, THAT CAN BE HARMFUL IF TOUCHED, SWALLOWED, OR INHALED. AVOID CONTACT WITH ANY FLUID OR POWDER IN OR AROUND THE UNIT. WHAT MAY APPEAR TO BE PLAIN WATER COULD CONTAIN THESE TOXIC SUBSTANCES. IN CASE OF EYE CONTACT, IMMEDIATELY FLUSH EYES WITH WATER FOR AT LEAST 15 MINUTES. CALL PHYSICIAN. (SEE APPENDIX, MATERIAL SAFETY DATA SHEET.)*

**CAUTION:** *Do not disturb the integrity of the cell package until the cell is to actually be used. If the cell package is punctured and air is permitted to enter, the cell will require a longer time to reach zero after installation.*

### 5.2.2 When to Replace a Cell

When the sensor in the 3000PA begins to fail, the analyzer usually requires more frequent calibration. If the 3000PA analysis readings drift downward uncharacteristically, try recalibration. If recalibration raises the readings temporarily, suspect the cell, but first check for leaks downstream from the cell where gases may be leaking into the system.

You can check the output of the cell itself by going to the *System* function, selecting *More*, and pressing *Enter*. The cell output reading will be on the second line of the display.

```
Version Self-Test
```

```
Cell Output: ### μA
```

The “good” cell output range depends on the class of cell your analyzer is using. The B-1 cell is standard in the 3000PA, but others can be specified.

**Check *Specific Model Information in the Front Matter in this manual for the class of cell you purchased.*** Then check Table 5-1, the cell index table below, and do the simple calculation. If the resulting value is below the Cell Output reading, replace the cell.

To find out if your cell is too weak:

1. Flow span gas through the analyzer, and allow time to purge.
2. With span gas flowing, read the raw output of the cell from the *System* function display.

3. Divide the raw output reading by the percent oxygen concentration of your span gas.

If the quotient is less than the Index value for the cell class you are using, replace the cell.

**Table 5-1: Cell Indices**

| Cell Class | Index |
|------------|-------|
| A-3        | 1.818 |
| A-5        | 1.818 |
| B-1        | 4.545 |
| B-3        | 3.716 |
| B-5        | 1.244 |
| B-7        | 1.515 |
| C-3        | 2.488 |
| C-5        | 0.606 |

### 5.2.3 Removing the Micro-Fuel Cell

The Micro-Fuel cell is located inside the nylon Probe behind the front panel. (See Figure 5-1.) To remove an existing cell:

1. Remove power to the instrument by unplugging the power cord at the power source.
2. Open the front panel door by pressing the release button on the top right corner of the door all the way in and releasing it.
3. Pull up on the nylon Probe, with a slight rocking motion, to release it from the Probe Receptacle.
4. **Do Not** remove the O-rings unless they are worn and no longer hold the Probe tightly. (If worn, replace them.)
5. When it is free, unscrew the Cap from the nylon Probe. **Hold the Probe vertically to prevent dropping the cell out of the probe.**
6. Remove the Cell from the Probe, and dispose of it in an environmentally safe manner.



**WARNING!**

**Risk of electric shock**

**High voltage exposed**

**at the end of enclosure!**

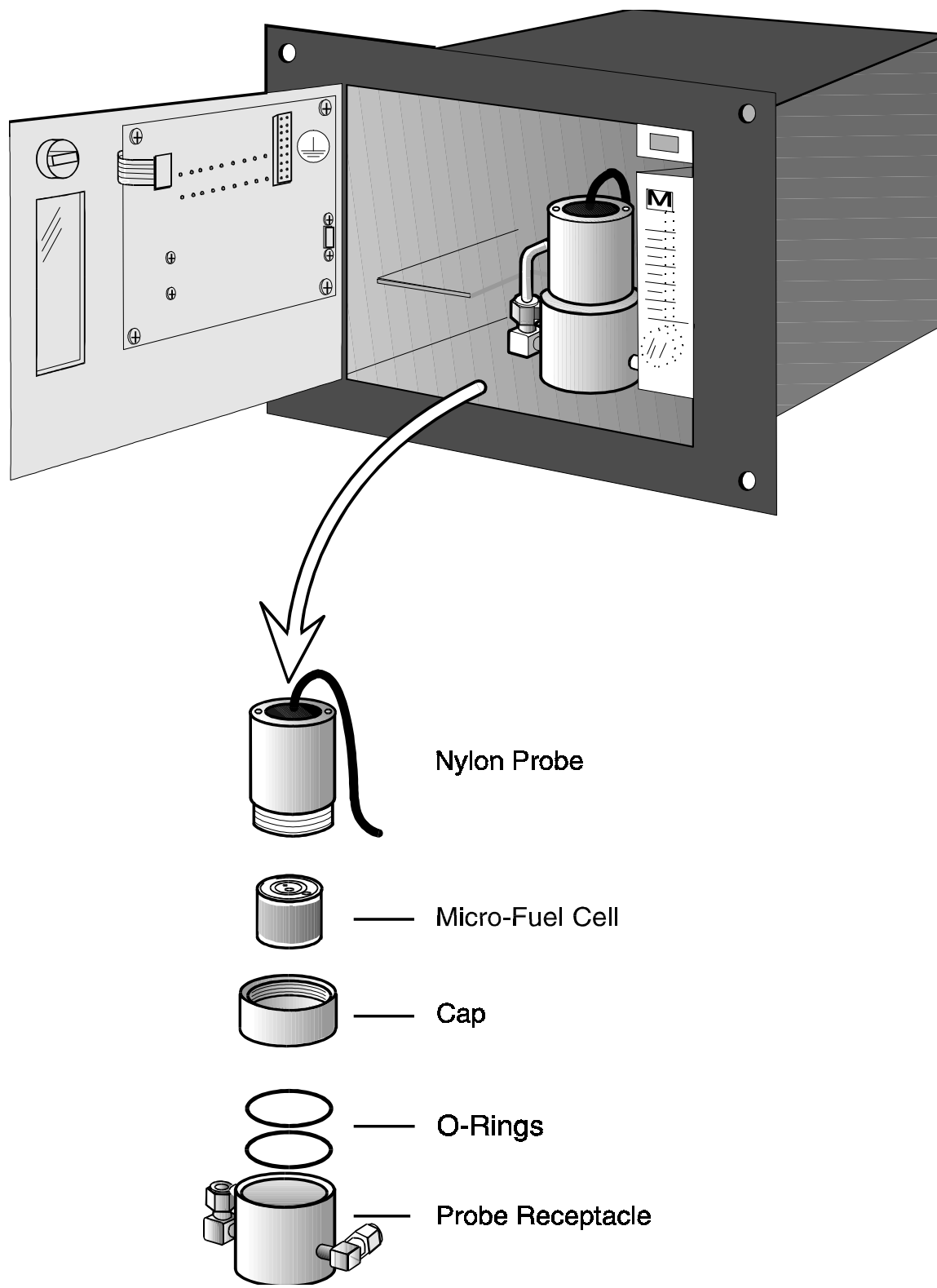

Figure 5-1: Removing or Installing a Micro-Fuel Cell

### 5.2.4 Installing a New Micro-Fuel Cell

**CAUTION:** *Do not touch the sensing surface of the cell. It is covered with a delicate Teflon membrane that can leak if punctured. The sensor must be replaced if the membrane is damaged.*



1. Place the Cell in the Probe with the sensing surface facing outward (toward the screen in the Cap).
2. Screw the Probe Cap onto the Probe until it stops.
3. With the O-rings in place, push the assembled Probe down into the Cell Holder—Cap Down—with a slight rocking motion until it is seated on the bottom of the holder. This forces the holder into position and forms a gas-tight seal.

### 5.2.5 Cell Warranty

The Class B-1 Micro-Fuel cell is standard in the Model 3000PA. This cell is warranted for 6 months from the date of shipment. Check the *Specific Model Information*, and note any Addendum that might be attached to the front of this manual for special information applying to the Cell in your instrument.

The warranty period for spare cells begins on the date of shipment. Do not purchase more than one spare cell per instrument. Do not stockpile spare cells.

**The B-1 cell is not designed for applications where CO<sub>2</sub> is a major component in the sample**, however slight amounts will not adversely effect the cell performance. Consult TAI for available options for either intermittent or continuous CO<sub>2</sub> exposure.

If a cell was working satisfactorily, but ceases to function before the warranty period expires, the customer will receive credit toward the purchase of a new cell.

If you have a warranty claim, you must return the cell in question to the factory for evaluation. If it is determined that failure is due to faulty workmanship or material, the cell will be replaced at no cost to you.

**NOTE: Evidence of damage due to tampering or mishandling will render the cell warranty null and void.**

### 5.3 Fuse Replacement

1. Place small screwdriver in notch, and pry cover off, as shown in Figure 5-2.

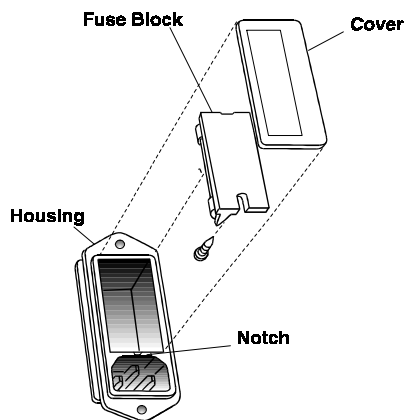

Figure 5-2: Removing Fuse Block from Housing

2. To change between American and European fuses, remove the single retaining screw, flip Fuse Block over 180 degrees, and replace screw.
3. Replace fuse as shown in Figure 5-3.
4. Reassemble Housing as shown in Figure 5-2.

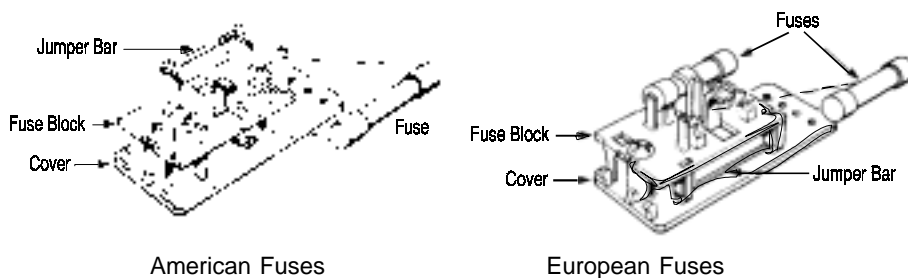

Figure 5-3: Installing Fuses

### 5.4 System Self Diagnostic Test

1. Press the *System* button to enter the system mode.
  2. Use the < > arrow keys to move to *More*, and press *Enter*.
  3. Use the < > arrow keys to move to *Self-Test*, and press *Enter*.
- The following failure codes apply:

**Table 5-1: Self Test Failure Codes****Power**

|   |              |
|---|--------------|
| 0 | OK           |
| 1 | 5 V Failure  |
| 2 | 15 V Failure |
| 3 | Both Failed  |

**Analog**

|   |                             |
|---|-----------------------------|
| 0 | OK                          |
| 1 | DAC A (0–1 V Concentration) |
| 2 | DAC B (0–1 V Range ID)      |
| 3 | Both Failed                 |

**Preamp**

|   |   |
|---|---|
| 0 | OK  |
| 1 | Zero too high                             |
| 2 | Amplifier output doesn't match test input |
| 3 | Both Failed                               |

## 5.5 Major Internal Components



The Micro-Fuel cell is accessed by unlatching and swinging open the front panel, as described earlier. Other internal components are accessed by removing the rear panel and sliding out the entire chassis. See Figure 5-4, below. The gas piping is illustrated in Figure 2-4, and the major electronic components locations are shown in Figure 2-5, in chapter 2.



**WARNINGS:** See warnings on the title page of this manual.

The 3000PA contains the following major components:

- Analysis Section
  - Micro Fuel Cell (B-1 standard—others available)
  - Nylon Probe and Holder
  - Sample System
- Power Supply
- Microprocessor
- Displays
  - 5 digit LED meter
  - 2 line, 20 character, alphanumeric, VFD display
- RS-232 Communications Port.

See the drawings in the Drawings section in back of this manual for details.

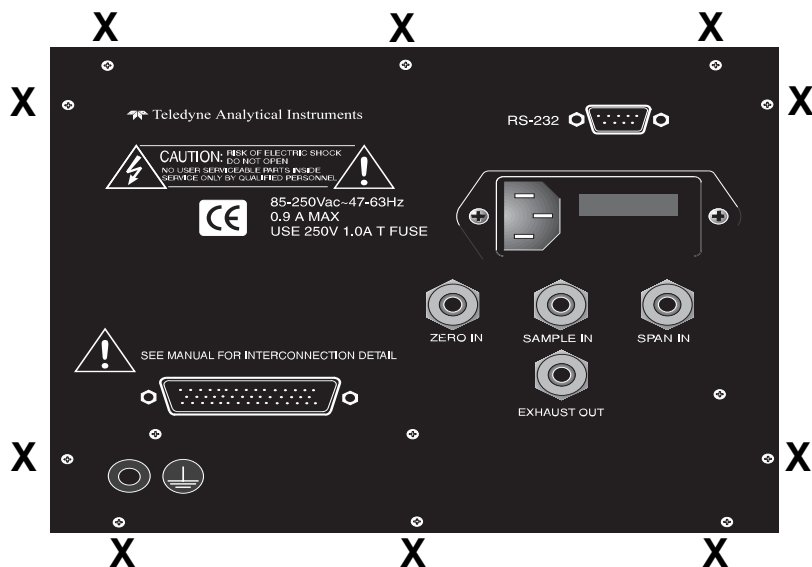

Figure 5-4: Rear-Panel Screws

To detach the rear panel, remove only the 14 screws marked with an X.

## 5.6 Cleaning

If instrument is unmounted at time of cleaning, disconnect the instrument from the power source. Close and latch the front-panel access door. Clean outside surfaces with a soft cloth dampened slightly with plain clean water. Do not use any harsh solvents such as paint thinner or benzene.

For panel-mounted instruments, clean the front panel as prescribed in the above paragraph. DO NOT wipe front panel while the instrument is controlling your process.

## 5.7 Troubleshooting

**Problem:**

Erratic readings of the Oxygen concentration as reported by the analyzer.

**Possible Cause:**

The analyzer may have been calibrated in an inaccurate fashion.

**Solution:**

Turn the analyzer off, then back on again. Press the System key when prompted by the analyzer "Press System for default Values". This will return the analyzer to its default settings in calibration and zero values. If erratic behavior continues replace the sensor.

**Possible Cause:**

Atmospheric Oxygen may be diffusing in through the vent and affecting the oxygen level which the sensor sees.

**Solution:**

Increase flow rate and/or length of vent tubing in order to dilute or minimize the diffusion of oxygen from the vent back to the sensor.

**Problem:**

Inaccurate zero operation (i.e. the user has zeroed the analyzer accidentally on gas much higher than one would normally use for a zero gas).

**Solution:**

Turn the analyzer off, then back on again. Press the System key when prompted by the analyzer "Press System for default Values". This will return the analyzer to its default settings in calibration and zero values. Now proceed to carefully calibrate and zero the analyzer.



---

## Appendix

---

### A-1 Model 3000PA Specifications

**Packaging: General Purpose**

- Flush panel mount (Standard).
- Rack mount — Relay rack mounted to contain either one or two instruments in one 19" relay rack mountable plate (Optional).

**Sensor:** Class B-1 Micro-Fuel Cell (standard). Others available.

**Cell Block:** Nylon.

**90 % Response Time:** 10 seconds at 25 °C (77 °F).

**Ranges:** Three user definable ranges from 0-1 % to 0-100 %, plus air calibration range of 0-25 %.

**Alarms:** One system-failure alarm contact to detect power failure.

Two adjustable concentration threshold alarms with fully programmable setpoints.

**Displays:** 2 line by 20 character, alphanumeric, VFD screen.  
One 5 digit LED display.

**Digital Interface:** Full duplex RS-232 communications port.

**Power:** Universal power supply 85-250 V ac, at 47-63 Hz, 0.9 A MAX.

**Operating Temperature:** 0-50 °C (32-122 °F).

**Relative Humidity:** 99%

**Altitude:** 1,609 m

**Accuracy:**  $\pm 2\%$  of full scale at constant temperature.  
 $\pm 5\%$  of full scale over operating temperature range, on factory default analysis ranges, once thermal equilibrium has been reached.

**Analog outputs:** 0-1 V dc percent-of-range (Standard)  
0-1 V dc range ID (Standard)  
4-20 mA dc—isolated—percent-of-range (Optional)  
4-20 mA dc—isolated—range ID (Optional)

**Dimensions:** 19 cm high  $\times$  24.9 cm wide  $\times$  31 cm deep  
(5.96"  $\times$  8.7"  $\times$  12.2").

## A-2 Recommended 2-Year Spare Parts List

| Qty | Part Number | Description                            |
|-----|-------------|--|
| 1   | C65507-B    | Back Panel Board                       |
| 1   | C62371      | Front Panel Board                      |
| 1   | C62368-B    | Percent Preamplifier Board             |
| 1*  | C62365-B    | Main Computer Board (std)              |
| 1*  | C62365-C    | Main Computer Board (4-20 mA)          |
| 2   | F1296       | Fuse, 2 A, 250 V, 5 × 20 mm, Slow Blow |
| 2   | O38         | O-ring                                 |
| 1** | C6689-B1    | Micro-Fuel Cell (for options see**)    |

\* Order -B or -C, not both.

\*\* Check *Specific Model Information* for cell in **your** instrument.

A minimum charge is applicable to spare parts orders.

**NOTE: Orders for replacement parts should include the part number (if available) and the model and serial number of the instrument for which the parts are intended.**

Orders should be sent to:

### TELEDYNE Analytical Instruments

16830 Chestnut Street  
City of Industry, CA 91749-1580

Phone (626) 934-1500, Fax (626) 961-2538  
TWX (910) 584-1887 TDYANYL COID

Web: [www.teledyne-ai.com](http://www.teledyne-ai.com)

or your local representative.

**A-3 Drawing List**

D-66317 Final Assembly/Outline Drawing

**A-4 19-inch Relay Rack Panel Mount**

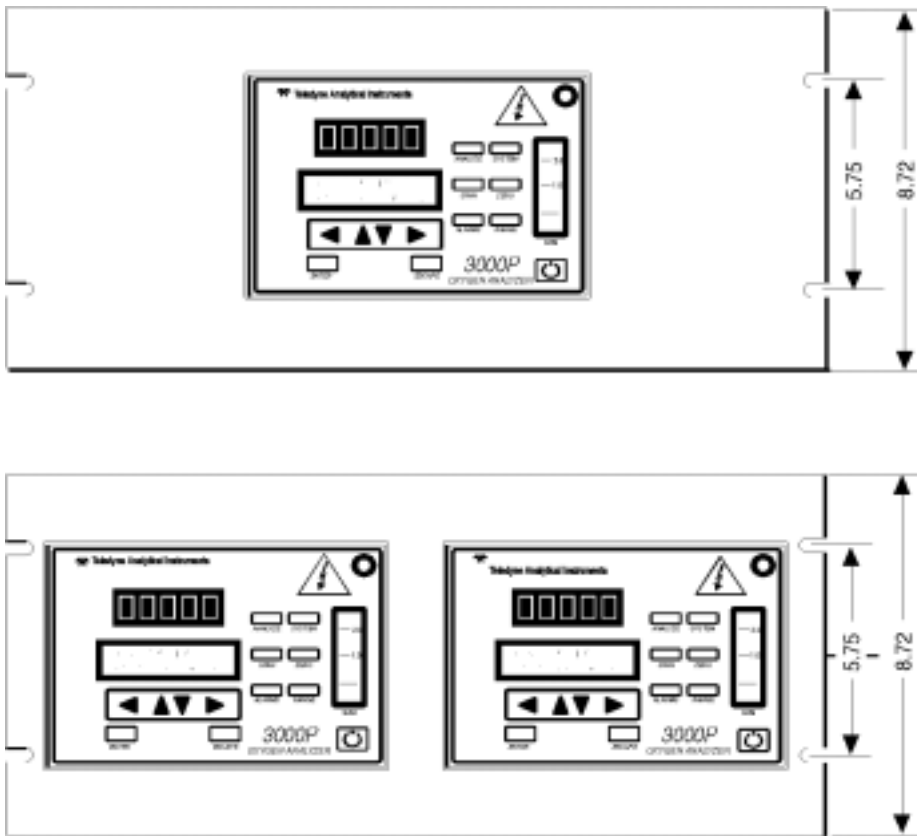

*Figure A-1: Single and Dual 19" Rack Mounts*

**A-5****3000 SERIES ANALYZERS  
APPLICATION NOTES ON RESTRICTORS,  
PRESSURES, AND FLOW RECOMMENDATIONS**

3000 series analyzers require reasonably regulated sample pressures. While the 3000 analyzers are not sensitive to variations of incoming pressure (provided they are properly vented to atmospheric pressure) the pressure must be maintained as to provide a useable flow rate through the analyzer. Any line attached to sample vent should be 1/4 or larger in diameter.

**FLOW RATE RECOMMENDATIONS:**

A usable flow rate for a 3000 series analyzer is one which can be measured on the flowmeter. This is basically .2 - 2.4 SLPM. The optimum flow rate is 1 SLPM (mid scale). Note: response time is dependent on flow rate, a low flow rate will result in slow response to O<sub>2</sub> changes in the sample stream. The span flow rate should be the approximately same as the sample flow rate.

**CELL PRESSURE CONCERNS:**

The sensors used in 3000 series analyzers are optimized to function at atmospheric pressure. At pressures other than atmospheric the diffusion rate of O<sub>2</sub> will be different than optimum value. Higher pressures will produce faster O<sub>2</sub> diffusion rates resulting in higher O<sub>2</sub> reading and shorter cell life. To use a 3000 series analyzer at a cell pressure other than atmospheric, the analyzer must be calibrated with a known calibration gas at the new cell pressure to adjust for the different diffusion rate. Cell pressures below 2/3 atmospheric are not recommended because as they tend to cause excessive internal expansion which may result in seal failure.

For operation at cell pressures other than atmospheric care must be taken not to change the sample pressure rapidly or cell damage may occur. For cell pressures above atmospheric, caution must be exercised to avoid over pressuring the cell holder. (percent analyzers will require some type of cell retainer to prevent the cell from being pushed out by the pressure.) For operation at pressures below atmospheric pressure a suffix C (clamped) cell is required.

**RESTRICTION DEVICES:**

For proper operation, all 3000 series analyzers require a flow restriction device. This device is typically a restrictor or a valve. This restriction device serves two functions in the sample path. The first function is to limit the flow rate of the sample through the analyzer. A restrictor is chosen to operate over a range of pressures and provide a useable flow rate over that range.

The second function that the restriction device provides is a pressure drop. This device is selected to provide the only significant pressure drop in the sample path.

## RESTRICTOR KIT

The current revision of the 3000 series analyzers are supplied with a kit containing two restrictors and a union which are user installed. These parts supplied to give the end user more flexibility when installing the analyzer. The restrictor kit is suitable for high and low positive pressure applications as well as vacuum service (atmospheric pressure sample) applications (see manual for installation instructions). The standard restrictor (BLUE DOT) is recommended for pressures between 5 PSIG and 50 PSIG. For positive low pressure application (5 psig or less) the un-marked restrictor is better suited. For none pressurized sample applications the marked restrictor should be used and configured for vacuum service. Note: for extremely low positive pressure applications (less than 2 psig) the vacuum service configuration should provide higher performance (higher flow rates). For vacuum service the end user must supply a vacuum pump and a by-pass valve for the pump. A vacuum level of 5 - 10 inches of mercury should provide the optimum flow rate. **CAUTION: flow restrictors have very small orifices and may be plugged by small particles (.005" dia or larger) A sample filter must be included in the sample line prior to the restrictor! (a 60 micron filter is recommended)**

## 3000PA EXAMPLES:

Example 1, with an incoming pressure of 10 psig the std restrictor (blue dot) will provide a flow rate of .76 SLPM. Up-stream of the restrictor the sample line pressure will be 10 psig, while down stream (including the cell) the pressure will be at atmospheric pressure. (analyzer vented to atmospheric pressure) Note, all other pressure drops in the sample path are insignificant at these flow rates. This insures that the cell operates at atmospheric pressure. At very high flow rates (off scale of flow-meter), pressure drops other than the restriction device could become significant, and result in pressurizing the cell.

Example 2, 3000PA is configured for vacuum service as follows. The un-marked restrictor is placed in the sample vent port. The down stream end of the restrictor is then connected to a vacuum pump and by-pass valve. The by-pass valve is adjusted to provide a flow rate of 1 SLPM. The sample pressure between the pump and the restrictor will be approximately -7 inches of mercury, while the pressure in the balance of the sample system including the cell will be approximately at atmospheric pressure. (provided the sample flow into the analyzer is not blocked.)

## BY-PASS:

To improve the system response, a by-pass can be added to increase the sample flow rate to the analyzer by a factor of ten. A by-pass provides a sample flow path around the analyzer of 2 - 18 SCFH. typically.

## CALIBRATION GAS:

3000 series analyzer requirements for units with Auto-Cal options. The

customer must supply a control valves (or restrictors) for any SPAN or ZERO gas source which is attached to the Auto-Cal ports. The valve should be adjusted to the same flow rate as the sample gas . When restrictors are used, the gas pressure must be adjusted to achieve the proper flow rate.

#### **OPERATION WITHOUT A RESTRICTOR DEVICE:**

Operation without a restrictor device is not recommend as mentioned above. A 3000PA without any flow restrictor device was tested on 11-19-97. This results in a flow rate of 2.4 SLPM @ 1 PSIG. This is a cv of 0.023 for the standard sample sys.

REFERENCE: FLOW\_1.XLS & FLOW\_2.XLS for information on flow rates at various pressures.

#### **TAI PART NUMBERS**

|                 |        |                               |
|-----------------|--------|-------------------------------|
| RESTRICTOR KIT: | A68729 |                               |
| UNION (SS)      | U11    |                               |
| LP.RESTRICTOR   | R2323  | (LOW PRESSURE / VAC. SERVICE) |
| STD..RESTRICTOR | R2324  | BLUE DOT                      |
| NUT             | N73    |                               |
| FERRULE         | F73    |                               |
| FERRULE         | F74    | BOTH FERRULES ARE<br>REQUIRED |

#### **CONVERSIONS:**

|        |   |                                  |
|--------|---|----------------------------------|
| 1 PSI  | = | 2.04 INCHES OF MERCURY (in. Hg.) |
| 1 SCFH | = | 0.476 SLPM                       |

## A-6 Zero Cal

The *Zero* button on the front panel is used to enter the zero calibration function. Zero calibration can be performed in either the automatic or manual mode. In the **automatic** mode, an internal algorithm compares consecutive readings from the sensor to determine when the output is within the acceptable range for zero. In the **manual** mode, the operator determines when the reading is within the acceptable range for zero. Make sure the zero gas is connected to the instrument. If zeroing is becoming more and more difficult, skip to section 4.4.1.3 *Cell Failure*.

### Auto Mode Zeroing

Press *Zero* to enter the zero function mode. The screen allows you to select whether the zero calibration is to be performed automatically or manually. Use the  $\Delta\nabla$  arrow keys to toggle between **AUTO** and **MAN** zero settling. Stop when **AUTO** appears, blinking, on the display.

```
Zero: Settling: AUTO
<ENT> To Begin
```

Press *Enter* to begin zeroing.

```
#### % Zero
Slope=#### ppm/s
```

The beginning zero level is shown in the upper left corner of the display. As the zero reading settles, the screen displays and updates information on **Slope** (unless the **Slope** starts within the acceptable zero range and does not need to settle further).

Then, and whenever **Slope** is less than 0.08 for at least 3 minutes, instead of **Slope** you will see a countdown: **5 Left**, **4 Left**, and so fourth. These are five steps in the zeroing process that the system must complete, **AFTER** settling, before it can go back to *Analyze*.

```
#### % Zero
4 Left=### ppm/s
```

The zeroing process will automatically conclude when the output is within the acceptable range for a good zero. Then the analyzer automatically returns to the *Analyze* mode.

### Manual Mode Zeroing

Press *Zero* to enter the *Zero* function. The screen that appears allows you to select between automatic or manual zero calibration. Use the  $\Delta\nabla$  keys

to toggle between AUTO and MAN zero settling. Stop when MAN appears, blinking, on the display.

Zero: Settling: Man  
<ENT> To Begin

Press *Enter* to begin the zero calibration. After a few seconds the first of five zeroing screens appears. The number in the upper left hand corner is the first-stage zero offset. The microprocessor samples the output at a predetermined rate. It calculates the differences between successive samplings and displays the rate of change as Slope= a value in parts per million per second (ppm/s).

##### % Zero  
Slope=##### ppm/s

**NOTE: It takes several seconds for the true Slope value to display. Wait about 10 seconds. Then, wait until Slope is sufficiently close to zero before pressing *Enter* to finish zeroing .**

Generally, you have a good zero when Slope is less than 0.05 ppm/s for about 30 seconds. When Slope is close enough to zero, press *Enter*. In a few seconds, the screen will update.

Once span settling completes, the information is stored in the microprocessor, and the instrument automatically returns to the *Analyze* mode.

**NOTE: The MSDS on this material is available upon request through the Teledyne Environmental, Health and Safety Coordinator. Contact at (626) 934-1592**



## A-5 Material Safety Data Sheet

### Section I – Product Identification

**Product Name:** Micro-Fuel Cells and Super Cells, all classes except A-2C, A-3, and A-5.

Electrochemical Oxygen Sensors, all classes except R-19.

Mini-Micro-Fuel Cells, all classes.

**Manufacturer:** Teledyne Analytical Instruments

**Address:** 16830 Chestnut Street, City of Industry, CA 91749

**Phone:** (818) 961-9221

**Customer Service:** Extension 222

**Environmental Health  
and Safety:** Extension 230

**Date Prepared :** 04/26/95

### Section II – Hazardous Ingredients/Composition

| Material or Component TLV              | C.A.S. #  | Quantity | OSHA PEL               | ACGIH                  |
|--|-----------|----------|------------------------|------------------------|
| Lead (Pb)                              | 7439-92-1 | 3–20 gms | 0.05 mg/m <sup>3</sup> | 0.15 mg/m <sup>3</sup> |
| Potassium Hydroxide Solution 15% (KOH) | 1310-58-3 | 1–5 ml   | None                   | 2 mg/m <sup>3</sup>    |

### Section III – Physical/Chemical Characteristics

| Material Appearance or Component | Boiling Point (°C) | Specific Gravity | Vapor Pressure | Melting Point (°C) | Density | Evap. Rate | Solubility in Water | Odor                              |
|----------------------------------|--------------------|------------------|----------------|--------------------|---------|------------|---------------------|-----------------------------------|
| Lead                             | 1744               | 11.34            | na             | 328                | na      | na         | Insoluble           | Solid, silver gray, odorless      |
| Potassium Hydroxide              | 1320               | 2.04             | na             | 360                | na      | na         | Complete            | White or slightly yellow, no odor |

## Section IV – Fire and Explosion Hazard Data

|  |  |                          |    |             |    |             |    |
|--|--|--------------------------|----|-------------|----|-------------|----|
| <b>Flash Point:</b>                        | na   | <b>Flammable Limits:</b> | na | <b>LEL:</b> | na | <b>UEL:</b> | na |
| <b>Extinguishing Media:</b>                | Use extinguishing media appropriate to surrounding fire conditions. No specific agents recommended.                        |                          |    |             |    |             |    |
| <b>Special Fire Fighting Equipment:</b>    | Wear NIOSH/OSHA approved self-contained breathing apparatus and protective clothing to prevent contact with skin and eyes. |                          |    |             |    |             |    |
| <b>Unusual Fire and Explosion Hazards:</b> | Emits toxic fumes under fire conditions.   |                          |    |             |    |             |    |

## Section V – Reactivity Data

|   |  |
|---|--|
| <b>Stability:</b>                             | Stable   |
| <b>Incompatibilities:</b>                     | Aluminum, organic materials, acid chlorides, acid anhydrides, magnesium, copper. Avoid contact with acids and hydrogen peroxide > 52%. |
| <b>Hazardous Decomposition of Byproducts:</b> | Toxic fumes  |
| <b>Hazardous Polymerization:</b>              | Will not occur.  |
| <b>Conditions to Avoid:</b>                   |  |

## Section VI – Health Hazard Data

|                         |   |
|-------------------------|---|
| <b>Routes of Entry:</b> | <b>Inhalation:</b> Highly unlikely<br><b>Ingestion:</b> May be fatal if swallowed.  |
| <b>Skin:</b>            | The electrolyte (potassium hydroxide) is corrosive; skin contact may cause irritation or chemical burns.  |
| <b>Eyes:</b>            | The electrolyte (potassium hydroxide) is corrosive; eye contact may cause irritation or severe chemical burns.  |
| <b>Acute Effects:</b>   | The electrolyte is harmful if swallowed, inhaled or adsorbed through the skin. It is extremely destructive to tissue of the mucous membranes, stomach, mouth, upper respiratory tract, eyes and skin.   |
| <b>Chronic Effects:</b> | Prolonged exposure with the electrolyte has a destructive effect on tissue.<br><br>Chronic exposure to lead may cause disease of the blood and blood forming organs, kidneys and liver, damage to the reproductive systems and decrease in fertility in men and women, and damage to the fetus of a pregnant woman. Chronic exposure from the lead contained in this product is extremely unlikely. |

|   |  |
|---|--|
| <b>Signs and Symptoms of Exposure:</b>                      | Contact of electrolyte with skin or eyes will cause a burning sensation and/or feel soapy or slippery to touch.<br><br>Other symptoms of exposure to lead include loss of sleep, loss of appetite, metallic taste and fatigue.   |
| <b>Carcinogenicity:</b>                                     | Lead is classified by the IARC as a class 2B carcinogen (possibly carcinogenic to humans)  |
| <b>OSHA:</b>  | Where airborne lead exposures exceed the OSHA action level, refer to <i>OSHA Lead Standard 1910.1025</i> .   |
| <b>NTP:</b>   | na   |
| <b>Medical Conditions Generally Aggravated by Exposure:</b> | Lead exposure may aggravate disease of the blood and blood forming organs, hypertension, kidneys, nervous and possibly reproductive systems. Those with preexisting skin disorders or eye problems may be more susceptible to the effects of the electrolyte.  |
| <b>Emergency First Aid Procedures:</b>                      | In case of contact with the skin or eyes, immediately flush with plenty of water for at least 15 minutes and remove all contaminated clothing. Get medical attention immediately.<br><br>If ingested, give large amounts of water and DO NOT INDUCE VOMITING. Obtain medical attention immediately.<br><br>If inhaled, remove to fresh air and obtain medical attention immediately. |

## Section VII – Precautions for Safe Handling and Use

**NOTE: The oxygen sensors are sealed, and under normal circumstances, the contents of the sensors do not present a health hazard. The following information is given as a guide in the event that a cell leaks.**

|   |  |
|---|--|
| <b>Protective measures during cell replacement:</b> | Before opening the bag containing the sensor cell, check the sensor cell for leakage. If the sensor cell leaks, do not open the bag. If there is liquid around the cell while in the instrument, wear eye and hand protection. |
| <b>Cleanup Procedures:</b>                          | Wipe down the area several times with a wet paper towel. Use a fresh towel each time. Contaminated paper towels are considered hazardous waste.  |

## Section VIII – Control Measures

|                                   |                         |
|-----------------------------------|-------------------------|
| <b>Eye Protection:</b>            | Chemical splash goggles |
| <b>Hand Protection:</b>           | Rubber gloves           |
| <b>Other Protective Clothing:</b> | Apron, face shield      |
| <b>Ventilation:</b>               | na                      |

## Section IX – Disposal

Both lead and potassium hydroxide are considered poisonous substances and are regulated under TSCA and SARA Title III.

|                          |   |
|--------------------------|---|
| EPA Waste Number:        | D008  |
| California Waste Number: | 181   |
| DOT Information:         | RQ Hazardous Waste Solid N.O.S. (Lead) Class 9<br>NA3077 PG III |
|                          | Follow all Federal, State and Local regulations.                |

## Section X – References

Material Safety Data Sheets from J.T. Baker Chemical, Aldrich, Malinckrodt, ASARCO  
U.S. Department of Labor form OMB No. 1218-0072  
Title 8 California Code of Regulations  
TSCA  
SARA Title III  
CFR 49  
CFR 29  
CFR 40

**NOTE: The above information is believed to be correct and is offered for your information, consideration, and investigation. It should be used as a guide. Teledyne Brown Engineering Analytical Instruments shall not be held liable for any damage resulting from handling or from contact with the above product.**